



MURRAY STATE
UNIVERSITY

Murray State's Digital Commons

Murray State Theses and Dissertations

Graduate School

2018

Distributive lattice models of the type C one-rowed Weyl group symmetric functions

William Atkins
Murray State University

Follow this and additional works at: <http://digitalcommons.murraystate.edu/etd>

 Part of the [Algebra Commons](#), [Discrete Mathematics and Combinatorics Commons](#), [Number Theory Commons](#), [Other Mathematics Commons](#), and the [Set Theory Commons](#)

Recommended Citation

Atkins, William, "Distributive lattice models of the type C one-rowed Weyl group symmetric functions" (2018). *Murray State Theses and Dissertations*. 101.
<http://digitalcommons.murraystate.edu/etd/101>

This Thesis is brought to you for free and open access by the Graduate School at Murray State's Digital Commons. It has been accepted for inclusion in Murray State Theses and Dissertations by an authorized administrator of Murray State's Digital Commons. For more information, please contact msu.digitalcommons@murraystate.edu.

Distributive lattice models of the type C one-rowed Weyl
group symmetric functions

A Thesis

Presented to

the Faculty of the Department of Mathematics and Statistics

Murray State University

Murray, Kentucky

In Partial Fulfillment

of the Requirements for the Degree

of Master of Science

by

William C. Atkins

01 May 2018

Acknowledgements

I would like to express my sincere gratitude to my thesis advisor, Dr. Donnelly, for his encouragement and advice, both academically and personally.

To my thesis committee members, Dr. Elizabeth Donovan and Dr. Timothy Schroeder, thank you for your suggestions and encouragement. Without the two of you and Dr. Donnelly, this thesis could not have been possible.

To the faculty of the Department of Mathematics and Statistics, thank you for the friendships these past two years. I will always cherish my time spent in the Ross Center and on the sixth floor of Faculty Hall.

To the Division of Mathematics at Bethel University, thank you for allowing me to realize my potential and to build toward my future.

To my parents, I can not say enough about the support you two have given me. I am beyond thankful.

To Aud

Abstract

We present two families of diamond-colored distributive lattices – one known and one new – that we can show are models of the type C one-rowed Weyl symmetric functions. These lattices are constructed using certain sequences of positive integers that are visualized as filling the boxes of one-rowed partition diagrams. We show how natural orderings of these one-rowed tableaux produce our distributive lattices as sublattices of a more general object, and how a natural coloring of the edges of the associated order diagrams yields a certain diamond-coloring property. We show that each edge-colored lattice possesses a certain structure that is associated with the type C Weyl groups. Moreover, we produce a bijection that shows how any two affiliated lattices, one from each family, are models for the same type C one-rowed Weyl symmetric function. While our type C one-rowed lattices have multiple algebraic contexts, this thesis largely focusses on their combinatorial aspects.

Contents

1	Introduction	1
2	Some general background	8
3	The type C one-rowed lattices	26
4	Some algebraic context	35
5	A gallery of type C examples	44

Chapter 1

Introduction

Finite partially ordered sets are fundamental mathematical objects that are ubiquitous in mathematics. Their uses range as widely as the organization of data structures in computer science [Knuth] to the analysis of phenotypes in genetics [Mark]. In this thesis, our interest in posets is two-fold: we will present two families of distributive lattices with many pleasant combinatorial, and particularly enumerative, properties which also serve as models (or potential models) for certain algebraic structures.

A simple, and perhaps canonical, example of a finite poset which has a distributive lattice structure is the Boolean lattice $\mathcal{B}(n)$, for a fixed positive integer n . This lattice can be defined as the set of all subsets of the n -element set $\mathcal{N} := \{1, 2, \dots, n\}$, partially ordered by subset containment. Of course, \mathcal{N} is the unique maximal element in this partial order, and \emptyset is the unique minimal element. Moreover, for subsets S and T , the subset $S \cup T$ is their unique least upper bound in $\mathcal{B}(n)$, and $S \cap T$ is their unique greatest lower bound. Then $\mathcal{B}(n)$ is distributive in the sense that \cup distributes over \cap , and vice-versa. Now, when a subset T has exactly one element in addition to a subset S , then there can be no subsets between S and T in this partial order; we say that T covers S , write $S \rightarrow T$, and think of this edge as being directed upward. That is, $S \rightarrow T$ if and only if $|T - S| = 1$ and $|S - T| = 0$. Note, then, that $|T|$ measures

the number of steps from the minimal element \emptyset and up to T , a quantity called the rank of T and denoted $\rho(T)$. Of course, the number of subsets of \mathcal{N} with integer size k is $\binom{n}{k}$. Then, the so-called rank generating function for $\mathcal{B}(n)$ is the q -polynomial

$$\text{RGF}(\mathcal{B}(n); q) := \sum_{T \subseteq \mathcal{N}} q^{\rho(T)} = \sum_{k=0}^n \binom{n}{k} q^k = (1 + q)^n.$$

Observe, then, that this rank generating function can be expressed as a product (thanks to the Binomial Theorem), that it is a symmetric polynomial (the sequence of coefficients has a symmetric pattern from beginning to end), and that it is a unimodal polynomial (the sequence of coefficients weakly increases up to some point and then weakly decreases from there). Moreover, specializing to $q = 1$ gives us a product formula for the cardinality of this lattice: $|\mathcal{B}(n)| = 2^n$.

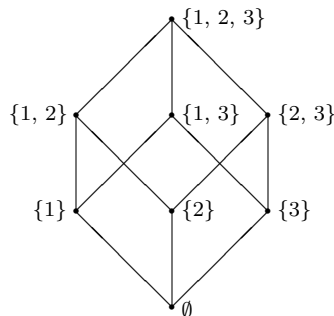
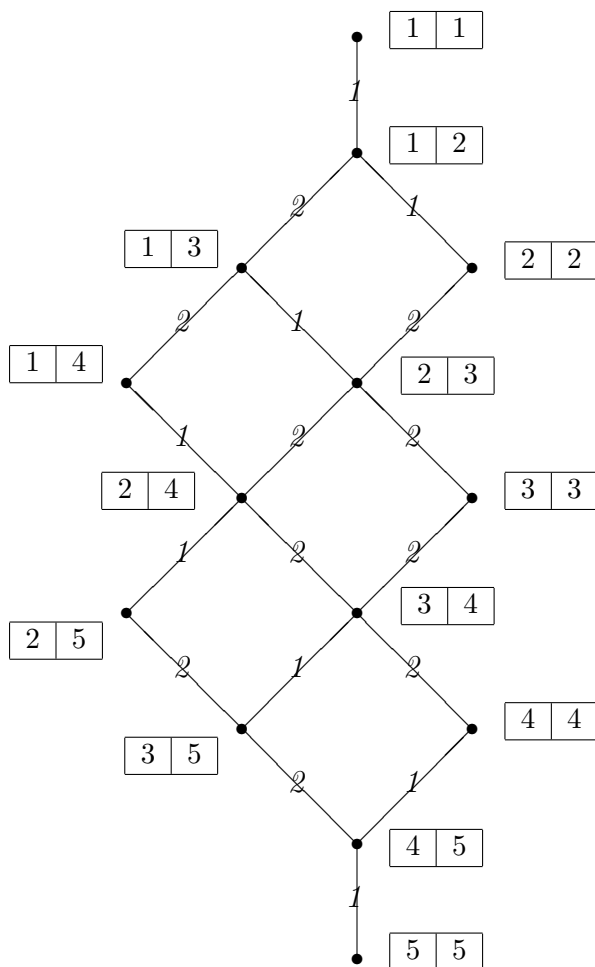

Figure 1.1 The Boolean lattice $\mathcal{B}(3)$

One aim of this thesis is to generalize some of the combinatorial phenomena of Boolean lattices to other settings which also have algebraic contexts. Antecedents for our work are the theses of McClard [Mc], Alverson [Alv], and Gilliland [Gil]. All of these theses were focussed on the problem of finding/studying distributive lattices that could potentially serve as models for certain representations of simple complex Lie algebras or for certain Laurent polynomials invariant under the action of the related Weyl group. In particular, [Mc] and [Alv] investigated partial orderings of objects called tableaux, which are positive integer fillings of the partition diagram

associated with some fixed integer partition. Very often, natural partial orderings of tableaux that descend from or are inspired by Lie theory have been found to exhibit many beautiful and intricate combinatorial and algebraic properties. Our overall objective here is to add to this preceding body of work.

Figure 1.2 The one-rowed lattice $L_{\mathbb{B}}^{RS}(2, 2\omega_1)$



Perhaps the most direct ancestor of our work here is the sequence of papers [DLP1] and [DLP2] by Donnelly, Lewis, and Pervine that studied two families of distributive lattices associated with certain irreducible representations of the simple complex odd orthogonal (type \mathbb{B}_n)* Lie algebra $\mathfrak{so}(2n + 1, \mathbb{C})$. Since special bases for each such

*The so-called “classical” Lie algebras are comprised of four infinite families associated with the finitary GCM graphs A_n , B_n , C_n , or D_n from Figure 2.1. The Lie algebra of type A_n is the (simple, complex) special linear Lie algebra $\mathfrak{sl}(n + 1, \mathbb{C})$ consisting of the $(n + 1) \times (n + 1)$ complex matrices

representation (called “weight bases”) can be indexed by tableaux whose shape is a single row of boxes, these were named “one-rowed” representations. The main results of [DLP1] and [DLP2] were a demonstration that each of the two families of diamond-colored distributive lattices are supporting graphs for two families of weight bases and the confirmation that these weight bases possess certain extremal properties by virtue of their unique identification with the type B_n lattices of those papers. These results relied crucially on the elegant combinatorics of the lattices presented there and yielded further combinatorial consequences (for example, a proof that the lattices of both families have the so-called “strong Sperner” property). Hereafter, we call these the type B one-rowed lattices. The Reiner-Stanton, or RS, family of type B one-rowed lattices are indexed by two positive integers and its constituents are notated $L_B^{RS}(n, k\omega_1)$, and the Molev family is similarly indexed and its members are notated $L_B^{Mol}(n, k\omega_1)$. The “ $k\omega_1$ ” of this notation is a reference to the dominant weights (cf. Ch. 4 or [DLP1]) associated with the one-rowed representations of the type B_n (odd orthogonal) Lie algebra. See Figures 1.2 and 1.3 for examples.

As the odd orthogonal Lie algebras are often closely linked with the symplectic Lie algebras (for example, the type B_n odd orthogonal Lie algebra and the type C_n symplectic Lie algebra have the same Weyl group), it makes sense to seek analogous type C_n distributive lattices for the one-rowed representations in the symplectic case. The one-rowed representations of the type C_n Lie algebras are at once both more well-behaved and less tractable than their odd orthogonal counterparts. Indeed, in a remark from [ADLP1], a family of distributive lattice supporting graphs was presented

with trace equal to zero. The Lie algebra of type B_n is the (simple, complex) special orthogonal Lie algebra $\mathfrak{so}(2n+1, \mathbb{C})$ consisting of the $(2n+1) \times (2n+1)$ skew-symmetric complex matrices; it is called “odd orthogonal” because the matrix dimension $2n+1$ is odd. The Lie algebra of type C_n is the (simple, complex) symplectic Lie algebra $\mathfrak{sp}(2n, \mathbb{C})$ consisting of the $2n \times 2n$ complex matrices that preserve a certain “symplectic” form; specifically, $A \in \mathfrak{sp}(2n, \mathbb{C})$ if and only if $A^T M + MA = O_{2n}$, where $M = \begin{pmatrix} O_n & I_n \\ -I_n & O_n \end{pmatrix}$, O_m is the $m \times m$ zero matrix, and I_m is the $m \times m$ identity matrix. The Lie algebra of type D_n is the (simple, complex) special orthogonal Lie algebra $\mathfrak{so}(2n, \mathbb{C})$ consisting of the $2n \times 2n$ skew-symmetric complex matrices; it is called “even orthogonal” because the matrix dimension $2n$ is even.

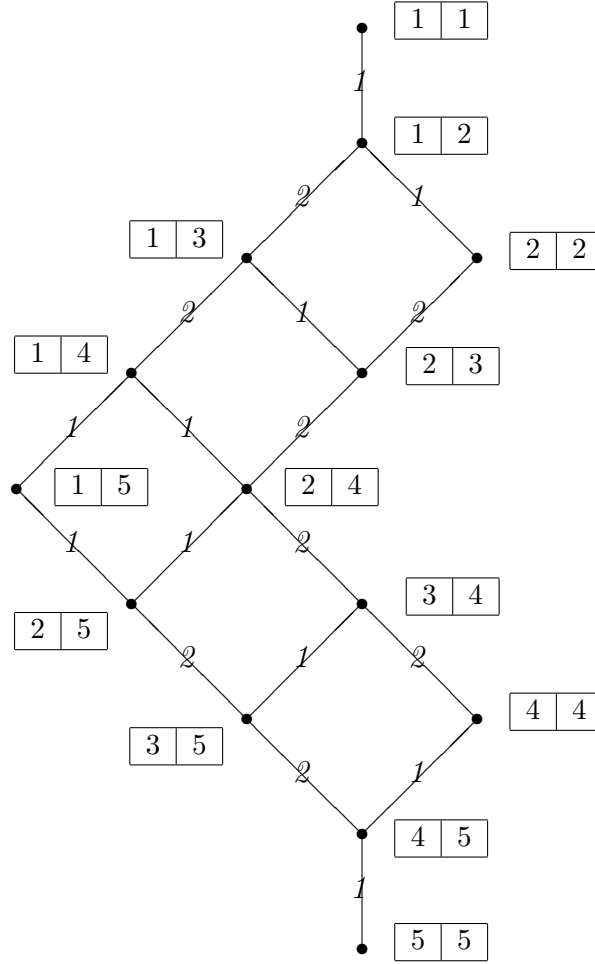
Figure 1.3 The one-rowed lattice $L_B^{Mol}(2, 2\omega_1)$ 

as an interpretation of a natural weight basis construction via symmetric powers of an originating, smallest symplectic Lie algebra representation. But a second companion family of one-rowed lattices in type C_n to analogize the second family of one-rowed lattices in type B_n was elusive.

Another aspect of the type B_n one-rowed lattices that was not explicitly noted in [DLP1] and [DLP2] is that, by virtue of their efficacy as models for the type B_n one-rowed representations, they also automatically become models for the related type B_n Weyl symmetric functions. Said more precisely (in language we more carefully develop later on), these B_n one-rowed lattices are splitting distributive lattices for the family $\{\chi_{k\omega_1}^{B_n}\}_{k \geq 1}$ of one-rowed B_n -Weyl symmetric functions.

Figure 1.4 Type C analogs of the foregoing type B one-rowed lattices

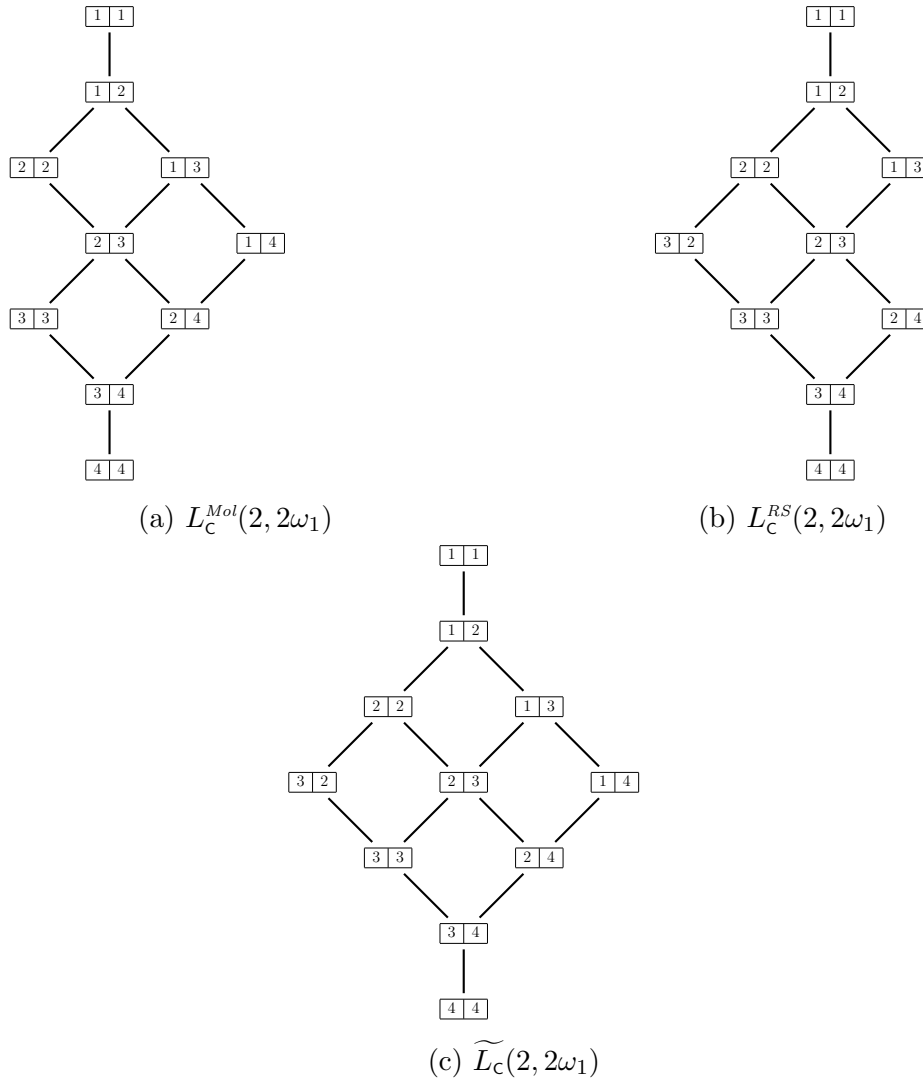

Our eventual goal here is to analogize this latter result to the type C_n setting. To this end, we will present two families of diamond-colored distributive lattices – one known and one new – and investigate their potential as splitting distributive lattices for the family $\{\chi_{k\omega_1}^{C_n}\}_{k \geq 1}$ of one-rowed C_n -Weyl symmetric functions. (For some examples whose notation is inspired by the type B one-rowed lattices, see Figure 1.4.) The primary contribution of this thesis is the demonstration of several requisite combinatorial results that set the stage for this desired Weyl symmetric function result. We will show that, relative to a certain weighting of the lattice

elements, each lattice is, in a precise sense (cf. Ch. 2), C_n -structured, and that there is a weight-preserving bijection between the pair of lattices associated with some given one-rowed C_n -Weyl symmetric function $\chi_{k\omega_1}^{C_n}$. Together with the aforementioned Lie algebraic result from [ADLP1], this last result is sufficient to conclude that the lattices of each such pair are splitting distributive lattices for $\chi_{k\omega_1}^{C_n}$. However, we believe that our combinatorial results will yield a more direct, non-Lie representation theoretic proof of the latter.

This presentation will require, of course, the development of several preliminaries, including some key notions from poset theory and from the theory of Weyl symmetric functions. We use certain type A_n one-rowed lattices as a running example to illustrate and clarify these various background ideas.

Chapter 2

Some general background

Our work takes place within the context of a famous classification result found by W. Killing in the 1880's and presented in what has been referred to as "The greatest mathematics paper of all time" [Col]. In that paper, Killing classified all of the simple complex Lie algebras. That this classification is not commonly featured as part of the general education of mathematicians owes perhaps to its origins as a Lie theoretic result, since a theory of Lie algebras sufficient to comprehend this classification is not easy to develop from scratch. However, there are other simpler contexts in which this classification arises and which are better suited to our purposes. We will reprise one of those contexts here.

The Networked-numbers Game. The *Networked-numbers Game* (most often simply called 'The Numbers Game') is a one-player combinatorial game played on a finite simple graph whose edges are assigned two integers we call amplitudes. The game begins with a choice of integers to place on the nodes of the graph; we refer to each such integer as a population. The only move allowed in the game is to (1) choose a node with a positive population (our reference population), (2) modify the population at each adjacent node by multiplying the reference population by the appropriate amplitude and adding this to the adjacent node population, and (3)

Figure 2.1: Connected finitary GCM graphs.

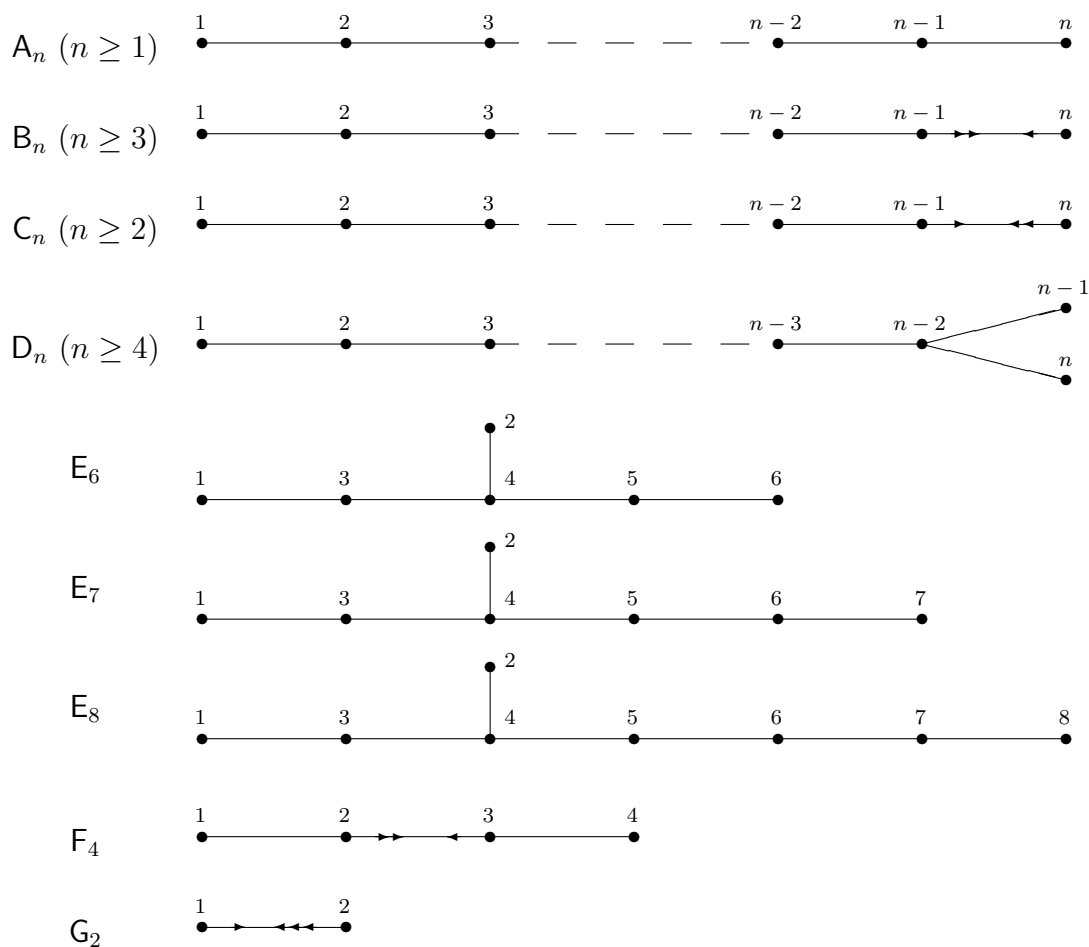

change the sign of the reference population after the populations at all adjacent nodes have been modified. This is called a node-firing move. The player continues the game until no node-firing moves are possible, i.e. until all populations are nonpositive. See Figure 2.2 below for an example.

A natural question, and indeed a crucial question from the point of view of combinatorics, is:

Which connected graphs actually possess a terminating Networked-numbers Games? The answer, which is proved in [Don2], is to be found in Figure 2.1. To further develop the content and context of that figure, we next provide a more precise set-up of the game and some related notions.

Formally, we take as our starting point some given simple graph Γ on n nodes. In

particular, Γ has no loops and no multiple edges. Nodes $\{\gamma_i\}_{i \in I_n}$ for Γ are indexed by elements of some fixed totally ordered set I_n of size n (usually $I_n = \{1 < 2 < \dots < n\}$). For each pair of adjacent nodes γ_i and γ_j in Γ , choose two negative integers a_{ij} and a_{ji} . Extend this to an $n \times n$ matrix $A = (a_{ij})_{i,j \in I_n}$ where, in addition to the negative integers a_{ij} and a_{ji} taken from the edges of Γ , we have $a_{ii} := 2$ for all $i \in I_n$ and $a_{ij} := 0$ if there is no edge in Γ between nodes γ_i and γ_j .

We call the pair (Γ, A) a *GCM graph*, since A is a ‘generalized Cartan matrix’ as in [Kac] and [Kum]. Generalized Cartan matrices have several algebraic contexts which we briefly mention here. Such matrices are the starting point for the study of Kac–Moody Lie algebras. These matrices also encode information about root systems and their associated Weyl groups. The latter provide a suitable environment for studying “Weyl symmetric functions,” which can be thought of as special multivariate Laurent polynomials which are invariant under a certain natural action of the Weyl group. An overarching goal of our work is to find nice poset models for such Weyl symmetric functions. See Ch. 4 for further development of the ideas in the preceding two sentences.

We say a GCM graph (Γ, A) is *connected* if Γ is. We depict a generic connected two-node GCM graph as $\gamma_1 \xrightarrow{p} \gamma_2 \xleftarrow{q}$, where $p = -a_{12}$ and $q = -a_{21}$. Those two-node GCM graphs which have $p = 1$ and $q = 1, 2,$ or 3 (respectively) have special names:

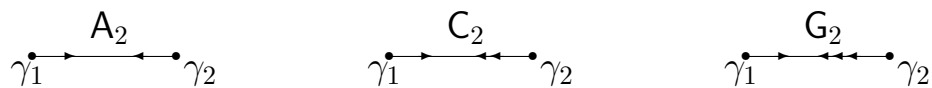

When $p = 1$ and $q = 1$ it is convenient to use the graph $\gamma_1 \xrightarrow{1} \gamma_2 \xleftarrow{1}$ to represent the GCM graph A_2 . A GCM graph (Γ, A) is *finitary* if each connected component of (Γ, A) (in the obvious sense) is one of the graphs of Figure 2.1. In exactly these cases, the affiliated root system and Weyl group are irreducible and finite and the related Kac–Moody algebra is simple and finite-dimensional, and we call the matrix A a *Cartan matrix*. We number the nodes of connected finitary GCM graphs as in §11.4

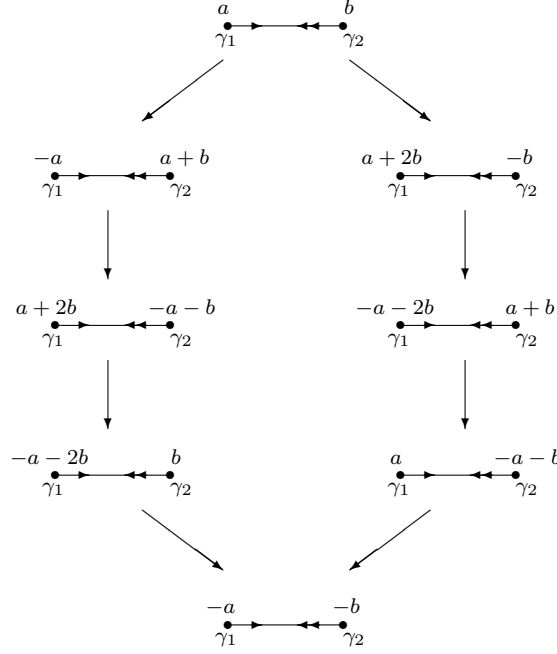
Figure 2.2: The numbers game for the finitary GCM graph C_2 .

of [Hum]. The special two-node GCM graphs A_2 , C_2 , and G_2 above are finitary GCM graphs with Cartan matrices $\begin{pmatrix} 2 & -1 \\ -1 & 2 \end{pmatrix}$, $\begin{pmatrix} 2 & -1 \\ -2 & 2 \end{pmatrix}$, and $\begin{pmatrix} 2 & -1 \\ -3 & 2 \end{pmatrix}$. Objects relating to some connected finitary GCM graph X_n , where $X \in \{A, B, C, D, E, F, G\}$, will be referred to as having/being of *type* X_n .

The moves of a Networked-numbers Game are naturally viewed as involutory linear transformations in the following way. To a given n -node GCM graph (Γ, A) with index set I , we associate the \mathbb{Z} -module of integer n -tuples $\Lambda := \mathbb{Z}^n$. Elements of Λ are called *weights*; a weight $\lambda = (\lambda_i)_{i \in I} \in \Lambda$ is *dominant* (respectively, *strongly dominant*) if each λ_i is nonnegative (resp. positive). For a fixed $j \in I$, the j^{th} *fundamental weight* is $(\delta_{ij})_{i \in I}$. For an $i \in I$, let α_i be the i th row vector of A . Let $S_i : \Lambda \rightarrow \Lambda$ be the transformation given by $S_i(\mu) := \mu - \mu_i \alpha_i$, where $\mu = (\mu_j)_{j \in I}$. One can easily check that S_i is \mathbb{Z} -linear and involutory (i.e. $S_i^2 = \text{Id}$, the identity transformation). Denote by $GL(\Lambda)$ the group of invertible \mathbb{Z} -linear transformations $\Lambda \rightarrow \Lambda$, and let $W(\Gamma, A) := \langle \{S_j\}_{j \in I} \rangle$ be the subgroup of $GL(\Lambda)$ generated by the S_i 's. We called $W(\Gamma, A)$ the *Weyl group* (or sometimes the *NNG group*) associated with the GCM

graph (Γ, A) .

We can identify each weight $\mu = (\mu_i)_{i \in I} \in \Lambda$ with a monomial $\mathbf{z}^\mu := \prod_{i \in I} z_i^{\mu_i}$, where the z_i 's are indeterminates. Let $\mathcal{L}(\Gamma, A)$ be the space of *Laurent polynomials* $\sum_{\mu \in \Lambda} c_\mu \mathbf{z}^\mu$ where the c_μ 's are integers and only finitely many are nonzero. The adjective “Laurent” makes reference to the fact that the integer exponents in a monomial \mathbf{z}^μ can be negative. Now, $W := W(\Gamma, A)$ acts on $\mathcal{L}(\Gamma, A)$ via the rule $S_i \cdot \mathbf{z}^\mu := \mathbf{z}^{S_i(\mu)}$ for any $i \in I$ and $\mu \in \Lambda$. An element $\chi \in \mathcal{L}(\Gamma, A)$ is a (Γ, A) -*Weyl symmetric function* if it is W -invariant, i.e. $S \cdot \chi = \chi$ for all $S \in W$. We use $\mathcal{L}(\Gamma, A)^W$ to denote the ring and \mathbb{Z} -module of (Γ, A) -Weyl symmetric functions.

In [Don2], Donnelly shows that the existence of a terminating numbers game played on a connected GCM graph from a (nontrivial) dominant weight is equivalent to the finiteness of the associated Weyl group, in which case the connected GCM graph is represented in Figure 2.1. Donnelly has recently learned that existence of a non-constant (Γ, A) -Weyl symmetric function is also equivalent to finiteness of $W(\Gamma, A)$.

So the study of such Weyl symmetric functions is necessarily a finitary subject. There is much interesting combinatorics (enumerative, order-theoretic, etc) that flows out of this subject. For example, the combinatorially rich, well-known, and well-developed subject of classical symmetric functions is merely the type **A** case of the more general Weyl symmetric function theory whose basic framework is articulated above. Our goal is to find interesting, and hopefully elegant and fruitful, combinatorial models for certain Weyl symmetric functions in other types. The combinatorial models we seek are posets whose structure should allow us to concretely understand related algebraic structures – especially certain Weyl symmetric functions – and whose algebraic context should allow us to infer further combinatorial properties of our poset models. That is, our poset models should be a two-way street between combinatorics and algebra.

A backgrounder on posets. Our interest is in finding combinatorially interesting partially ordered sets that exhibit and model aspects of the various algebraic structures related to the connected finitary GCM graphs, most particularly their Weyl symmetric functions. Next we provide a brief overview of poset concepts most pertinent to our purposes. We mostly follow the notation and terminology of [DDDS] and references therein, which can be consulted for more detail. We note that the use of edge-coloring below is intended to connect us back to the world of (Γ, A) GCM graphs. More specifically, the X_n -structure property connects a poset directly to the action of the generators of the Weyl group $W(\Gamma, A)$. This tie-in between Weyl group invariant Laurent polynomials and the combinatorics of posets will be further developed in Ch. 4, but we have developed some of the details here because we want the reader to have this context at least partly in mind for the combinatorics that will follow.

Given a poset P with partial ordering relation “ \leq ” (reflexive, anti-symmetric, transitive), a *covering relation* is an ordered pair of poset elements $(\mathbf{x}, \mathbf{y}) \in P \times P$ with the property that $\mathbf{x} = \mathbf{z}$ or $\mathbf{y} = \mathbf{z}$ whenever $\mathbf{x} \leq \mathbf{z} \leq \mathbf{y}$. We depict the ordered pair (\mathbf{x}, \mathbf{y}) as a directed edge $\mathbf{x} \rightarrow \mathbf{y}$. The *order diagram* for this poset, also denoted by P , is the directed graph whose vertices are the poset elements and whose directed edges are the covering relations. When needed, we use the notation $\mathcal{V}(P)$ to denote the vertex set of the order diagram and $\mathcal{E}(P)$ to denote the set of directed edges. All posets in this paper are finite. When we depict posets, edges will be directed upward, so arrowheads on directed edges will often not be drawn. We apply graph theoretic notions (connectedness, adjacency of vertices, etc) to a poset by applying them to its order diagram.

A poset R is *ranked* if there is a nonnegative integer ℓ and a surjective function $\rho : R \rightarrow \{0, 1, \dots, \ell\}$ for which $\rho(\mathbf{x}) + 1 = \rho(\mathbf{y})$ for any covering relation $\mathbf{x} \rightarrow \mathbf{y}$. The number ℓ is the *length* of R with respect to the *rank function* ρ . The related *depth*

function $\delta : R \rightarrow \{0, 1, \dots, \ell\}$ is given by $\delta(\mathbf{x}) := \ell - \rho(\mathbf{x})$. (If R is connected, then the rank and depth functions are unique.) This ranked poset is *rank symmetric* if, for each integer $r \in \{0, 1, \dots, \ell\}$ we have $|\rho^{-1}(r)| = |\rho^{-1}(\ell - r)|$. It is *rank unimodal* if, for some integer $u \in \{0, 1, \dots, \ell\}$, we have

$$|\rho^{-1}(0)| \leq |\rho^{-1}(1)| \leq \dots \leq |\rho^{-1}(u-1)| \leq |\rho^{-1}(u)| \geq |\rho^{-1}(u+1)| \geq \dots \geq |\rho^{-1}(\ell-1)| \geq |\rho^{-1}(\ell)|.$$

We define the *rank generating function* $\text{RGF}(R; q)$ by the rule

$$\text{RGF}(R; q) := \sum_{\mathbf{x} \in R} q^{\rho(\mathbf{x})} = \sum_{i=0}^{\ell} |\rho^{-1}(i)| q^i,$$

a polynomial in the variable q wherein the coefficient of the term containing q^i is the number of elements of R which have rank i .

We now consider posets which have some additional structure. A *lattice* L is a poset for which any two given elements \mathbf{x} and \mathbf{y} of L have a (unique) least upper bound, denoted $\mathbf{x} \vee \mathbf{y}$ and called their *join*, and a (unique) greatest lower bound, denoted $\mathbf{x} \wedge \mathbf{y}$ and called their *meet*. Observe that such a lattice is necessarily connected and has a unique maximal element $\mathbf{max}(L)$ and a unique minimal element $\mathbf{min}(L)$. This lattice is *modular* if and only if L is ranked and $\rho(\mathbf{x} \wedge \mathbf{y}) + \rho(\mathbf{x} \vee \mathbf{y}) = \rho(\mathbf{x}) + \rho(\mathbf{y})$ for any $\mathbf{x}, \mathbf{y} \in L$. The lattice L is *distributive* if and only if it meets distribute over joins and vice-versa; that is, $\mathbf{x} \wedge (\mathbf{y} \vee \mathbf{z}) = (\mathbf{x} \wedge \mathbf{y}) \vee (\mathbf{x} \wedge \mathbf{z})$ and $\mathbf{x} \vee (\mathbf{y} \wedge \mathbf{z}) = (\mathbf{x} \vee \mathbf{y}) \wedge (\mathbf{x} \vee \mathbf{z})$ for any given $\mathbf{x}, \mathbf{y}, \mathbf{z} \in L$. Any distributive lattice is modular, but not all modular lattices are distributive.

Some of the preceding notions can be usefully “colorized.” A set I of order n will serve as our set of “colors”; for convenience, in the following discussion we take I to be $\{1, 2, \dots, n\}$. A poset P together with a function $\mathbf{edgecolor} : \mathcal{E}(P) \rightarrow I$ is an *edge-colored poset*. An edge $\mathbf{x} \rightarrow \mathbf{y}$ in P with color $i \in I$ is denoted $\mathbf{x} \xrightarrow{i} \mathbf{y}$. Assuming P is edge-colored and $J \subseteq I$, then the *J-component* of an element $\mathbf{x} \in P$ is the

connected subgraph $\mathbf{comp}_J(\mathbf{x})$ of the order diagram of P whose vertices and edges are obtained as follows: The vertices $\mathcal{V}(\mathbf{comp}_J(\mathbf{x}))$ are all those poset elements that can be reached from \mathbf{x} by traversing a path whose edge colors are in J (we disregard edge directions when traversing edges along such a path); the edges $\mathcal{E}(\mathbf{comp}_J(\mathbf{x}))$ are all edges from $\mathcal{E}(P)$ whose colors are in J and which are incident with some vertex in $\mathcal{V}(\mathbf{comp}_J(\mathbf{x}))$. A modular lattice is *diamond-colored* if whenever  is an edge-colored subgraph of the affiliated order diagram, then $i = l$ and $j = k$. In a diamond-colored modular (respectively distributive) lattice, for all lattice elements \mathbf{x} and all edge-color subsets J we have that $\mathcal{V}(\mathbf{comp}_J(\mathbf{x}))$ is the order diagram for a modular (respectively distributive) lattice.

Now suppose R is a ranked poset with edges colored by the set I . Then for any $\mathbf{x} \in R$ and any $i \in I$, the i -component $\mathbf{comp}_i(\mathbf{x})$ is ranked with a unique rank function ρ_i and a unique depth function δ_i . We define the weight of \mathbf{x} , denoted $wt(\mathbf{x})$, to be the integer n -tuple

$$wt(\mathbf{x}) = \left(\rho_i(\mathbf{x}) - \delta_i(\mathbf{x}) \right)_{i \in I}.$$

Let z_1, z_2, \dots, z_n be variables, and for an integer n -tuple $\mu = (\mu_1, \mu_2, \dots, \mu_n)$ declare that $z^\mu := z_1^{\mu_1} z_2^{\mu_2} \cdots z_n^{\mu_n}$. The *weight generating function* $\text{WGF}(R; z_1, \dots, z_n)$ in the variables z_1, \dots, z_n is defined by the rule

$$\text{WGF}(R; z_1, \dots, z_n) := \sum_{\mathbf{x} \in R} z^{wt(\mathbf{x})}.$$

Now let \mathbf{X}_n be a connected finitary GCM graph from Figure 2.1, and for any $i \in I$, let α_i be the i^{th} row vector of the associated Cartan matrix $A = (a_{ij})_{i,j \in I}$. We say the edge-colored ranked poset R is \mathbf{X}_n -structured if $wt(\mathbf{x}) + \alpha_i = wt(\mathbf{y})$ whenever $\mathbf{x} \xrightarrow{i} \mathbf{y}$ in R . This condition is equivalent to the assertion that for any edge $\mathbf{x} \xrightarrow{i} \mathbf{y}$ in R and

for any $j \neq i$, we have

$$\rho_j(\mathbf{x}) - \delta_j(\mathbf{x}) + a_{ij} = \rho_j(\mathbf{y}) - \delta_j(\mathbf{y}).$$

In Ch. 4, we will see that when R is X_n -structured and has i -components exhibiting a certain kind of easily-checked symmetry, then $\text{WGF}(R; z_1, \dots, z_n)$ is invariant with respect to a natural action of the type X_n Weyl group, i.e. $\text{WGF}(R; z_1, \dots, z_n)$ is an X_n -Weyl symmetric function.

Very often in our work, the combinatorial objects of interest occur naturally as substructures of other objects. In this paragraph, we briefly remark on the poset substructures that are most useful for our purposes here. Given a subset P of a poset Q , let P inherit the partial ordering of Q ; call P a *subposet in the induced order*. For posets (P, \leq_P) and (Q, \leq_Q) , suppose $P \subseteq Q$ and $\mathbf{x} \leq_P \mathbf{y} \Rightarrow \mathbf{x} \leq_Q \mathbf{y}$ for all $\mathbf{x}, \mathbf{y} \in P$. Then P is a *weak subposet* of Q . We apply the language of edge-coloring to subposets in the obvious ways. Now let L be a lattice with partial ordering \leq_L and meet and join operations \wedge_L and \vee_L respectively. Let K be a vertex subset of L . Suppose that K has a lattice partial ordering \leq_K of its own with meet and join operations \wedge_K and \vee_K respectively. We say K is a *sublattice* of L if for all \mathbf{x} and \mathbf{y} in K we have $\mathbf{x} \wedge_K \mathbf{y} = \mathbf{x} \wedge_L \mathbf{y}$ and $\mathbf{x} \vee_K \mathbf{y} = \mathbf{x} \vee_L \mathbf{y}$. It is easy to see that if K is a sublattice of L then for all \mathbf{x} and \mathbf{y} in K we have $\mathbf{x} \leq_K \mathbf{y}$ if and only if $\mathbf{x} \leq_L \mathbf{y}$. That is, K is a weak subposet of L and a subposet in the induced order. If, in addition, K and L are edge-colored and K is an edge-colored weak subposet of L , then call K an *edge-colored sublattice* of L . Whether or not K and L are edge-colored, if K is a sublattice of L , if both K and L are ranked, and if both have the same length, then we say K is a *full-length sublattice* of L . In this case, for any given $\mathbf{x}, \mathbf{y} \in K$, it can be seen that the rank of \mathbf{x} as an element of K is the same as its rank as an element of L and that \mathbf{y} covers \mathbf{x} in K if and only if \mathbf{y} covers \mathbf{x} in L . Therefore such a lattice

K naturally inherits an edge-coloring of L . We record (and mildly extend) some of these observations in the following lemma.

Lemma 2.1 *Let L be a diamond-colored distributive lattice. Suppose K is a subset of L for which $\mathbf{x} \vee \mathbf{y}$ and $\mathbf{x} \wedge \mathbf{y}$ are in K whenever $\mathbf{x}, \mathbf{y} \in K$. Give K the induced order from L . Then K is a sublattice of L , and K is a distributive lattice when regarded as a poset on its own. Moreover, if K is a full-length sublattice, then every edge in K is also an edge in L and K is diamond-colored when its edge coloring is inherited from L . \square*

The type A one-rowed lattices. Fix positive integers N and k with $N \geq 2$. To illustrate the ideas which we are extending in this thesis, we will begin by considering some classical distributive lattices that are indexed by these two integer parameters. These distributive lattices are type A objects in that they are \mathbf{A}_{N-1} -structured and have a well-understood relationship with certain irreducible representations of the type \mathbf{A}_{N-1} simple complex special linear Lie algebra and certain type \mathbf{A}_{N-1} -Weyl symmetric functions. We explore some of these latter connections in Ch. 4, and here focus on combinatorial features. In particular, the type \mathbf{A}_{N-1} connection is made by imposing a certain coloring on the edges of the order diagrams for these lattices.

A *type \mathbf{A}_{N-1} one-rowed tableau of length k* is a k -tuple $T = (T_1, T_2, \dots, T_k)$ with $1 \leq T_1 \leq T_2 \leq \dots \leq T_k \leq N$. (Such a k -tuple can be viewed as a k -element *multisubset* of the set $\{1, 2, \dots, N\}$, in that the elements comprising T are allowed to repeat.) We view each such k -tuple T as a row of k boxes filled from left to right with the integers T_1, T_2, \dots, T_k :

$$\boxed{T_1} \boxed{T_2} \cdots \boxed{T_k}.$$

We let $L_{\mathbf{A}}(n, k\omega_1)$ be the set consisting of all type \mathbf{A}_{N-1} one-rowed tableaux of length k partially ordered by *reverse-componentwise comparison*, i.e. if $S = (S_1, \dots, S_k)$ and

$T = (T_1, \dots, T_k)$ are in $L_A(N-1, k\omega_1)$, then $S \leq T$ if and only if $S_i \geq T_i$ for each $i \in \{1, 2, \dots, k\}$. It is a simple exercise to verify that $L_A(N-1, k\omega_1)$ is a lattice with $S \vee T = (\min\{S_i, T_i\})_{i=1}^n$ and $S \wedge T = (\max\{S_i, T_i\})_{i=1}^n$ as the join and meet respectively of any two given length k type A_{N-1} one-rowed tableaux S and T . By Lemma 2.2.3 of [Mc], it follows that $L_A(N-1, k\omega_1)$ is a distributive lattice. Various depictions of these lattices are interspersed throughout the following narrative.

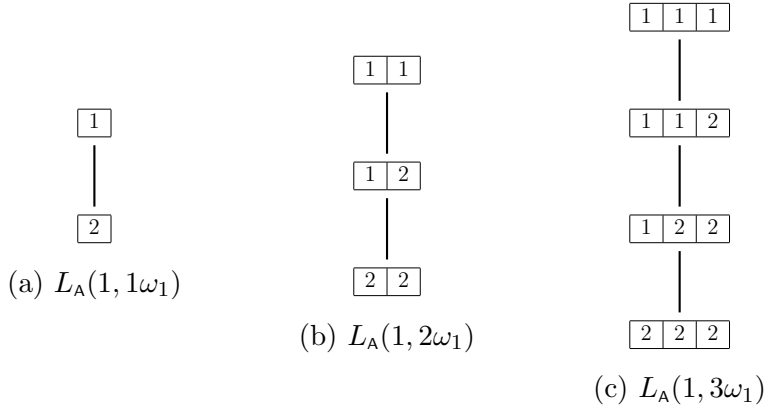

Before addressing the edge-coloring scheme for the order diagram of $L_A(N-1, k\omega_1)$, we remark briefly on some of its enumerative aspects. In this paragraph, we sometimes use “ L ” as an abbreviation for “ $L_A(N-1, k\omega_1)$.” Now, the number of k -element multisubsets taken from $\{1, 2, \dots, N\}$ is a number often denoted $\left(\binom{N}{k}\right)$ and called a *multi-choose* coefficient. A simple and classic enumerative exercise is to establish the following identity of multi-choose and binomial coefficients: $\left(\binom{N}{k}\right) = \binom{N-1+k}{k}$. Since the one-rowed tableaux in L can be exactly identified with the k -element multisubsets of $\{1, 2, \dots, N\}$, then the size of L is

$$\text{CARD}(L_A(N-1, k\omega_1)) = \left(\binom{N}{k}\right).$$

We define the q -multi-choose coefficient $\left(\left(\begin{matrix} N \\ k \end{matrix}\right)\right)_q$ in the same way that the q -binomial coefficient $\binom{N-1+k}{k}_q$ is defined, namely as the quotient

$$\frac{[N-1+k]_q [N-1+k-1]_q \cdots [N-1+k-(k-1)]_q}{[k]_q!} = \frac{[N-1+k]_q [N-1+k-1]_q \cdots [N]_q}{[k]_q!},$$

where the q -integer $[m]_q := q^{m-1} + q^{m-2} + \cdots + q + 1 = \frac{q^m - 1}{q - 1}$ and the q -factorial $[m]_q! := [m]_q [m-1]_q \cdots [2]_q [1]_q$ are defined in the usual way when m is a positive integer, and $[0]_q := 0$ (as an empty sum) and $[0]_q! := 1$ (as an empty product). As easy calculation shows that the q -multi-choose coefficients satisfy the recurrence

$$\left(\left(\begin{matrix} m \\ j \end{matrix}\right)\right)_q = q^j \left(\left(\begin{matrix} m-1 \\ j \end{matrix}\right)\right)_q + \left(\left(\begin{matrix} m \\ j-1 \end{matrix}\right)\right)_q$$

for positive integers m and j , and with $\left(\left(\begin{matrix} m \\ 0 \end{matrix}\right)\right)_q = 1$ for $m \geq 0$ and $\left(\left(\begin{matrix} 0 \\ j \end{matrix}\right)\right)_q = 0$ for $j > 0$. Now, the rank of a tableau T in L is easily seen to be

$$\rho(T) = kN - \sum_{i=1}^k T_i.$$

In Proposition 2.2.(4) below, we prove that $\sum_{T \in L} q^{\rho(T)} =: \text{RGF}(L_A(N-1, k\omega_1); q) = \left(\left(\begin{matrix} N \\ k \end{matrix}\right)\right)_q$.

Now, any edge of the order diagram for $L_A(N-1, k\omega_1)$ is a covering relation $S \rightarrow T$ wherein there is some $q \in \{1, 2, \dots, k\}$ such that $S_q - 1 = T_q$ while $S_p = T_p$ when $p \in \{1, 2, \dots, k\} \setminus \{q\}$. In this case, $T_q \in \{1, 2, \dots, N-1\}$; we let $i := T_q$ be the color of this order diagram edge and write $S \xrightarrow{i} T$. It is easy to verify that with respect to this edge coloring, $L_A(N-1, k\omega_1)$ is a diamond-colored distributive lattice. Therefore we may consider the weight $wt(T) = (\rho_i(T) - \delta_i(T))_{i=1}^{N-1}$ of a generic tableau T from $L_A(N-1, k\omega_1)$. In Proposition 2.2.(2) below we demonstrate that

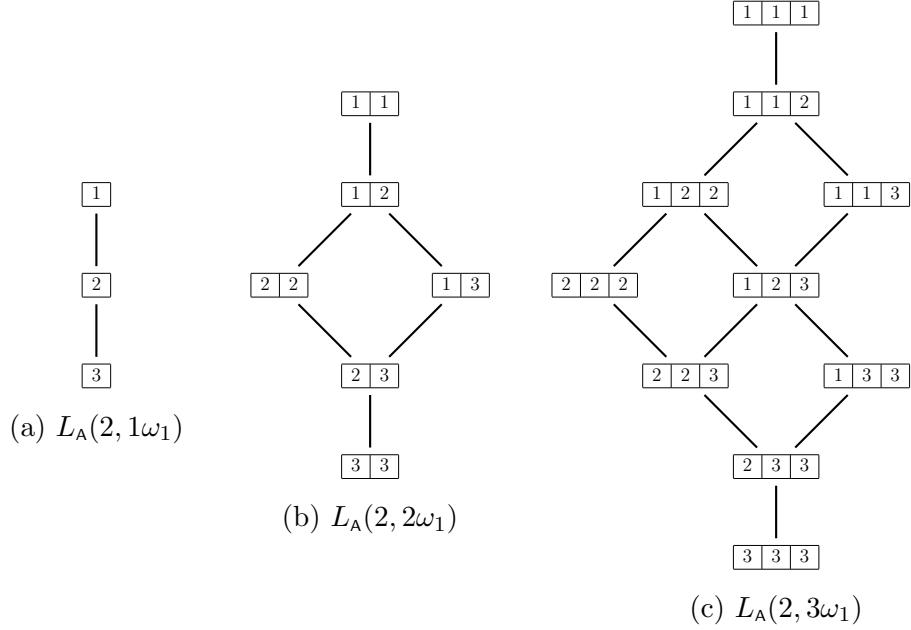

this integer $(N - 1)$ -tuple can be computed in terms of the quantities $\#(T, i)$ for the indices $i \in \{1, 2, \dots, N - 1\}$, where $\#(T, i)$ counts the number of times i appears as a entry in T .

This family of diamond-colored distributive lattices arises in two algebraic contexts of interest to us. A complete understanding of these contexts is not necessary in order to understand the combinatorics that follows; however, these contexts certainly strongly motivate our interest, so we briefly mention them here and offer more detail in Ch. 4. First, the given lattice $L_A(N - 1, k\omega_1)$ is the unique supporting graph for what we will call the k^{th} “one-rowed representation” of the simple complex special linear Lie algebra $\mathfrak{sl}(N, \mathbb{C})$. This representation can be realized as the k^{th} symmetric power of the N -dimensional defining representation of $\mathfrak{sl}(N, \mathbb{C})$. Up to a certain notion of equivalence, there is only one possible weight basis for this representation, and this weight basis has supporting graph $L_A(N - 1, k\omega_1)$. Second, $L_A(N - 1, k\omega_1)$ is the unique splitting poset for what we will call the k^{th} “one-rowed \mathbf{A}_{N-1} -Weyl symmetric function” denoted $\chi_{k\omega_1}^{\mathbf{A}_{N-1}}$, which is a Laurent polynomial in $N - 1$ variables that is invariant under a natural action of the symmetric group S_N .

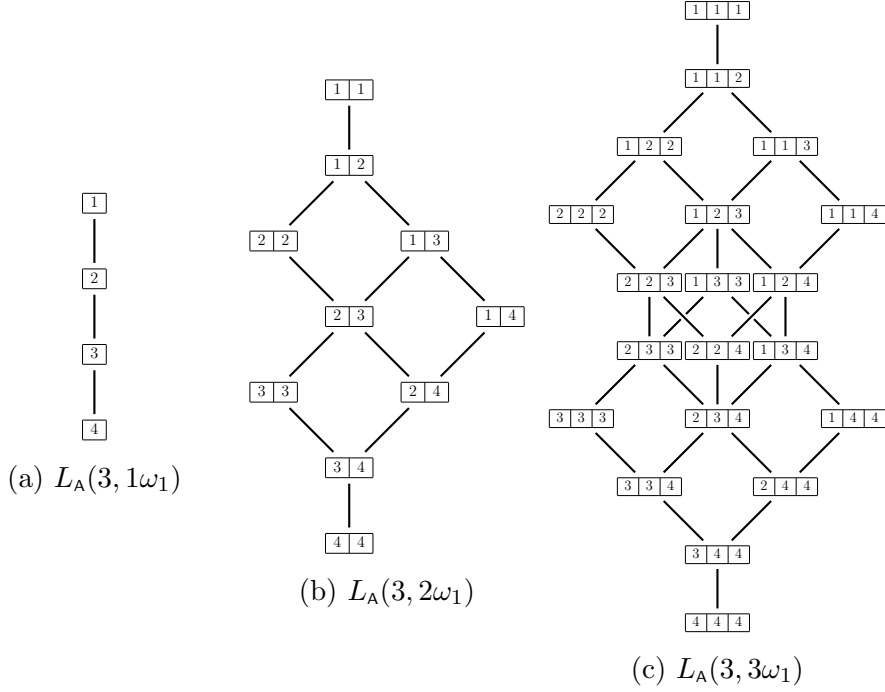

Some of the more desirable combinatorial features of $L_A(N - 1, k\omega_1)$ are direct consequences of the fact that this lattice serves as a model for the k^{th} one-rowed irreducible representation of $\mathfrak{sl}(N, \mathbb{C})$ and for the k^{th} one-rowed A_{N-1} -Weyl symmetric function. In particular, it can be concluded that this lattice is rank symmetric, rank unimodal, and strongly Sperner, and that its rank-generating function is expressible as a quotient of products. Certain of the preceding conclusions can be obtained directly, which we record in the next proposition.

Proposition 2.2 *The following are facts about the one-rowed lattice $L_A(N - 1, k\omega_1)$:*

(1) *Now let $T = (T_1, \dots, T_k)$ be a one-rowed tableau from $L_A(N - 1, k\omega_1)$. Then*

$$wt(T) = (\#(T, 1) - \#(T, 2), \#(T, 2) - \#(T, 3), \dots, \#(T, N - 1) - \#(T, N)).$$

(2) *$L_A(N - 1, k\omega_1)$ is A_{N-1} -structured.*

(3) We have the following well-known identity:

$$\text{RGF}(L_A(N-1, k\omega_1); q) = \left(\left(\binom{N}{k} \right) \right)_q = \binom{N-1+k}{k}_q.$$

That is, the rank generating function of $L_A(N-1, k\omega_1)$ is the q -multi-choose coefficient $\left(\left(\binom{N}{k} \right) \right)_q$, which is also the q -binomial coefficient $\binom{N-1+k}{k}_q$.

Proof. For part (1), suppose our tableau T has the following form:

$$\boxed{\cdots \mid T_p = i \mid T_{q-1} = i \mid \cdots \mid T_{q-1} = i \mid T_q = i+1 \mid \cdots \mid T_q = i+1 \mid T_r = i+1 \mid \cdots}$$

where $T_{p-1} < i$ (if $p > 1$) and $T_{r+1} > i+1$ (if $r < k$), and possibly $\#(T, i) = 0$ and $\#(T, i+1) = 0$. Observe that there are $q-p$ steps from T down to the minimal element of $\mathbf{comp}_i(T)$ and $r-q+1$ steps from T up to the maximal element of $\mathbf{comp}_i(T)$. So $\rho_i(T) = \#(T, i)$ and $\delta_i(T) = \#(T, i+1)$, so $\rho_i(T) - \delta_i(T) = \#(T, i) - \#(T, i+1)$.

To prove (2), we note that it is enough to check that for any distinct edge colors i and j and any edge $S \xrightarrow{i} T$, we have

$$\rho_j(S) - \delta_j(S) + a_{ij} = \rho_j(T) - \delta_j(T), \quad (2.0.1)$$

where a_{ij} is the (i, j) -entry of the \mathbf{A}_{N-1} GCM with rows/columns indexed in concert with the node labels of the (finitary) GCM graph \mathbf{A}_{N-1} from Figure 2.1. Now, by (1), $\rho_j(X) - \delta_j(X) = \#(X, j) - \#(X, j+1)$ for any tableau X . So, first suppose that indices i and j correspond to adjacent nodes in the GCM graph \mathbf{A}_{N-1} with $j = i+1$, so $a_{i,j} = -1 = a_{j,i}$. Since T is formed from S by changing some entry $S_q = i+1$ to $T_q = i$ whilst all other S_p 's and T_p 's coincide, then we have: $\rho_{i+1}(S) - \delta_{i+1}(S) + a_{i,i+1} = \#(S, i+1) - 1 - \#(S, i+2) = \#(T, i+1) - \#(T, i+2) = \rho_{i+1}(T) - \delta_{i+1}(T)$, thereby verifying equation (1) above when $j = i+1$. A similar argument establishes (1) under the supposition $j = i-1$. Finally, suppose i and j correspond to distant nodes in the

Dynkin diagram for \mathbf{A}_{N-1} , so $|j - i| > 1$. Now, T is formed from S by changing an $i + 1$ in S to an i . Since any j and $j + 1$ entries in S are distant from its i and $i + 1$ entries, then T will have the same j and $j + 1$ entries as S . That is, $\rho_j(S) - \delta_j(S) = \rho_j(T) - \delta_j(T)$. Since $a_{i,j} = 0$ in this case, we get $\rho_j(S) - \delta_j(S) + a_{i,j} = \rho_j(T) - \delta_j(T)$.

Now we prove the identity in (3). It is well-known that, if we ignore edge colors, the one-rowed lattice $L_{\mathbf{A}}(N - 1, k\omega_1)$ is isomorphic to the type \mathbf{A}_{N-1} elementary lattice $L_{\mathbf{A}}(k, N - 1)$ via the correspondence $T = (T_1, \dots, T_k)$ in $L_{\mathbf{A}}(N - 1, k\omega_1)$ becomes the columnar tableau $T' = (T_1, T_2 + 1, T_3 + 2, \dots, T_k + k - 1)$ in $L_{\mathbf{A}}(k, N - 1)$. Since $\text{RGF}(L_{\mathbf{A}}(k, N - 1); q) = \binom{N-1+k}{k}_q$, then $\text{RGF}(L_{\mathbf{A}}(N - 1, k\omega_1); q) = \binom{N-1+k}{k}_q$.

This same result can be obtained more directly as follows. Partition the one-rowed tableaux of $L_{\mathbf{A}}(N - 1, k\omega_1)$ into two disjoint subsets, namely, those one-rowed tableaux which contain an “ N ” and those which do not, denoted $\mathcal{S}_{N?Yes}$ and $\mathcal{S}_{N?No}$ respectively. The induced-order subposet $\mathcal{S}_{N?No}$ is clearly isomorphic to $L_{\mathbf{A}}(N - 2, k\omega_1)$, and the rank of the minimal element $(N - 1, N - 1, \dots, N - 1)$ of $\mathcal{S}_{N?No}$ in $L_{\mathbf{A}}(N - 1, k\omega_1)$ is k . The induced-order subposet $\mathcal{S}_{N?Yes}$ is clearly isomorphic to $L_{\mathbf{A}}(N - 1, (k - 1)\omega_1)$, and its minimal element (N, N, \dots, N) is the minimal element of $L_{\mathbf{A}}(N - 1, k\omega_1)$. Therefore

$$\text{RGF}(L_{\mathbf{A}}(N - 1, k\omega_1); q) = q^k \text{RGF}(L_{\mathbf{A}}(N - 2, k\omega_1); q) + \text{RGF}(L_{\mathbf{A}}(N - 1, (k - 1)\omega_1); q),$$

which coincides with the above-noted recurrence of q -multi-choose coefficients:

$$\left(\binom{N}{k} \right)_q = q^k \left(\binom{N-1}{k} \right)_q + \left(\binom{N}{k-1} \right)_q.$$

□

The type B one-rowed lattices. Before presenting our type C one-rowed lattices, we will summarize and mildly re-contextualize work from [DLP1] with the type B one-rowed lattices. Fix positive integers n and k , and define a recoloring function

$\sigma : \{1, 2, \dots, 2n\} \longrightarrow \{1, 2, \dots, n\}$ by the rule

$$\sigma(i) := \begin{cases} i & \text{if } i \in \{1, 2, \dots, n\} \\ 2n + 1 - i & \text{if } i \in \{n + 1, n + 2, \dots, 2n\} \end{cases}.$$

Now let $\widetilde{L}_B(n, k\omega_1)$ be the diamond-colored distributive lattice formally denoted by $L_A(2n, k\omega_1)^\sigma$, i.e. the lattice obtained by giving each color i edge of $L_A(2n, k\omega_1)$ the color $\sigma(i)$.

Next, we apply Lemma 2.1 in order to locate two special sublattices of $\widetilde{L}_B(n, k\omega_1)$. First, let $L_B^{Mol}(n, k\omega_1)$ be the induced-order subposet of $\widetilde{L}_B(n, k\omega_1)$ consisting of those one-rowed tableaux $T = (T_1, \dots, T_k)$ with the property that $\#(T, n + 1) \leq 1$. Now, it is clear that for tableaux $S, T \in L_B^{Mol}(n, k\omega_1)$, the tableau $(\min\{S_i, T_i\})_{i=1}^k = S \vee T$ in L resides in $L_B^{Mol}(n, k\omega_1)$ and the tableau $(\max\{S_i, T_i\})_{i=1}^k = S \wedge T$ also resides in $L_B^{Mol}(n, k\omega_1)$. Further, one can discern that $L_B^{Mol}(n, k\omega_1)$ is a full-length sublattice of $\widetilde{L}_B(n, k\omega_1)$ (as $X := \mathbf{min}(\widetilde{L}_B(n, k\omega_1))$ and $Y := \mathbf{max}(\widetilde{L}_B(n, k\omega_1))$ are both in $L_B^{Mol}(n, k\omega_1)$ and there is a path of edges from X up to Y that stays in $L_B^{Mol}(n, k\omega_1)$ and has the same length as $\widetilde{L}_B(n, k\omega_1)$), and therefore its edges are a subset of the edges of the larger lattice and inherit their edge colors. Second, let $L_B^{RS}(n, k\omega_1)$ be the induced-order subposet of $\widetilde{L}_B(n, k\omega_1)$ consisting of those one-rowed tableaux $T = (T_1, \dots, T_k)$ with the property that $T_k < 2n$ whenever $T_1 = 1$. As in the previous case, one can see that $L_B^{RS}(n, k\omega_1)$ is closed under the join and meet operations, that it is a full-length sublattice of $\widetilde{L}_B(n, k\omega_1)$, and that the edges of $L_B^{RS}(n, k\omega_1)$ are edges from $\widetilde{L}_B(n, k\omega_1)$ and inherit their edge colors. So, both $L_B^{Mol}(n, k\omega_1)$ and $L_B^{RS}(n, k\omega_1)$ are diamond-colored distributive sublattices of $\widetilde{L}_B(n, k\omega_1)$.

Results for $\widetilde{L}_B(n, k\omega_1)$, $L_B^{RS}(n, k\omega_1)$, and $L_B^{Mol}(n, k\omega_1)$ similar to Proposition 2.2 are established implicitly in [DLP1] but without the same systematic intentionality best suited to our purposes here.

Theorem 2.3 cf. [DLP1] *Let L be one of $\widetilde{L}_B(n, k\omega_1)$, $L_B^{RS}(n, k\omega_1)$, or $L_B^{Mol}(n, k\omega_1)$.*

Then:

(1) For a one-rowed tableau $T = (T_1, \dots, T_k)$ in L , we have

$$\begin{aligned} wt(T) = & \left(\#(T, 1) - \#(T, 2) + \#(T, 2n) - \#(T, 2n + 1), \dots, \#(T, i) - \#(T, i + 1) \right. \\ & + \#(T, 2n + 1 - i) - \#(T, 2n + 2 - i), \dots, \#(T, n - 1) - \#(T, n) \\ & \left. + \#(T, n + 2) - \#(T, n + 3), 2\#(T, n) - 2\#(T, n + 2) \right). \end{aligned}$$

(2) L is \mathbb{B}_n -structured.

(3) There exists a weight-preserving bijection $\varphi : L_{\mathbb{B}}^{RS}(n, k\omega_1) \longrightarrow L_{\mathbb{B}}^{Mol}(n, k\omega_1)$, so that

$$\text{WGF}(L_{\mathbb{B}}^{RS}(n, k\omega_1); z_1, z_2, \dots, z_n) = \text{WGF}(L_{\mathbb{B}}^{Mol}(n, k\omega_1); z_1, z_2, \dots, z_n).$$

Moreover, $\text{RGF}(L_{\mathbb{B}}^{RS}(n, k\omega_1); q) = \text{RGF}(L_{\mathbb{B}}^{Mol}(n, k\omega_1); q)$

$$= \binom{2n + k}{k}_q - q^{2n} \binom{2n + k - 2}{k - 2}_q.$$

Proof. The proof of part (1) can be found within the penultimate paragraph of the proof of Theorem 2.1 of [DLP1]; the final paragraph of that proof demonstrates part (2) of the above theorem statement. For part (3), an explicit formulation of such a bijection φ can be found in the Introduction of [DLP1], where it is noted that this bijection is rank-preserving. It is easy to see that the bijection is weight-preserving as well. That $\text{RGF}(L_{\mathbb{B}}^{RS}(n, k\omega_1); q)$, and hence $\text{RGF}(L_{\mathbb{B}}^{Mol}(n, k\omega_1); q)$, have rank generating functions of the form prescribed in the theorem statement above is established in [RS], although this also follows as a corollary of Theorem 2.1 of [DLP1]. \square

Chapter 3

The type **C** one-rowed lattices

In this chapter, we present type C_n analogs of the type B_n one-rowed lattices and prove in Theorems 3.1 and 3.2 that they possess certain crucial combinatorial features. These theorems are the main results of this thesis. In particular, Theorem 3.2.(2) most strongly connects our type C_n one-rowed lattices to the action of the Weyl group associated with the type C_n finitary GCM graph and (mostly) shows that the weight-generating functions for these one-rowed lattices are $W(C_n)$ -invariant; see Ch. 4 for further discussion of these algebraic contexts.

We begin by presenting a family of large type C_n lattices that will contain the lattices of interest to us as sublattices. These large lattices analogize the type B_n lattices denoted $\widetilde{L}_B(n, k\omega_1)$. Define

$$\widetilde{L}_C(n, k\omega_1) := \left\{ \boxed{T_1 \mid T_2 \mid \cdots \mid T_k} \mid (*) \right\},$$

where $(*)$ is the requirement that $1 \leq T_i \leq T_{i+1} \leq 2n$ for each $1 \leq i \leq k-1$ unless $(T_i, T_{i+1}) = (n+1, n)$ with $T_{i-1} \leq n$ (if $1 \leq i-1$) and $T_{i+2} \geq n+1$ (if $i+2 \leq k$). We partially order $\widetilde{L}_C(n, k\omega_1)$ by reverse-componentwise comparison, as with the type **A** and **B** one-rowed lattices. For S and T in $\widetilde{L}_C(n, k\omega_1)$, we have a covering relation $S \rightarrow T$ if there is a $q \in \{1, \dots, k\}$ with $T_q = S_q - 1$ while $T_p = S_p$ for $p \neq q$. In this

case, we write $S \xrightarrow{i} T$ if $T_q \in \{i, 2n - i\}$.

Next, we define the subsets

$$(\text{Molev}) L_c^{\text{Mol}}(n, k\omega_1) := \left\{ \boxed{T_1 \mid T_2 \mid \cdots \mid T_k} \in \widetilde{L}_c(n, k\omega_1) \mid T_i \leq T_{i+1} \forall 1 \leq i \leq k-1 \right\}$$

and

$$(\text{RS}) L_c^{\text{RS}}(n, k\omega_1) := \left\{ \boxed{T_1 \mid T_2 \mid \cdots \mid T_k} \in \widetilde{L}_c(n, k\omega_1) \mid 1 = T_1 \Rightarrow T_k < 2n \right\},$$

and we give these subsets the induced order. A one-rowed tableau T from $\widetilde{L}_c(n, k\omega_1)$ that also resides in $L_c^{\text{Mol}}(n, k\omega_1)$ (respectively, $L_c^{\text{RS}}(n, k\omega_1)$) is *Molev-admissible* (resp. *RS-admissible*); otherwise T is *Molev-inadmissible* (resp. *RS-inadmissible*). In our next result, we will demonstrate that $\widetilde{L}_c(n, k\omega_1)$ is a diamond-colored distributive lattice and that each of $L_c^{\text{Mol}}(n, k\omega_1)$ and $L_c^{\text{RS}}(n, k\omega_1)$ are full-length sublattices. Then, we will regard edges and edge colors of $L_c^{\text{Mol}}(n, k\omega_1)$ and $L_c^{\text{RS}}(n, k\omega_1)$ to be inherited from $\widetilde{L}_c(n, k\omega_1)$.

Theorem 3.1 *Take $\widetilde{L}_c(n, k\omega_1)$, $L_c^{\text{Mol}}(n, k\omega_1)$, and $L_c^{\text{RS}}(n, k\omega_1)$ as above. Then $\widetilde{L}_c(n, k\omega_1)$ is a diamond-colored distributive lattice, and $L_c^{\text{Mol}}(n, k\omega_1)$ and $L_c^{\text{RS}}(n, k\omega_1)$ are full-length distributive sublattices.*

Proof. We begin by considering the edge-colored lattice $L(n) := \widetilde{L}_c(n, \omega_1) = L_c^{\text{Mol}}(n, \omega_1) = L_c^{\text{RS}}(n, \omega_1)$, which is a chain with $2n$ elements and therefore length $2n - 1$. Let $L(n)^{\times k} := L(n) \times L(n) \times \cdots \times L(n)$, an edge-colored product poset in the usual way, with k factors of $L(n)$. Then $L(n)^{\times k}$ is a diamond-colored distributive lattice in the reverse-componentwise order, with $X \vee Y = (\min\{X_i, Y_i\})_{i=1}^k$ and $X \wedge Y = (\max\{X_i, Y_i\})_{i=1}^k$ for any $X, Y \in L(n)^{\times k}$.

To prove that $\widetilde{L}_c(n, k\omega_1)$ is a diamond-colored distributive lattice, it suffices by Lemma 2.1 to prove that $\widetilde{L}_c(n, k\omega_1)$ is a full-length sublattice of $L(n)^{\times k}$ that is closed under joins and meets. For closure, it suffices to prove that if $S = (S_1, \dots, S_k)$ and $T = (T_1, \dots, T_k)$ are any one-rowed tableaux in $\widetilde{L}_c(n, k\omega_1)$, then their reverse-componentwise minimum $U := (\min\{S_i, T_i\})_{i=1}^k = S \vee T$ in $L(n)^{\times k}$ resides in $\widetilde{L}_c(n, k\omega_1)$ and that their reverse-componentwise maximum $R := (\max\{S_i, T_i\})_{i=1}^k = S \wedge T$ in

$L(n)^{\times k}$ also resides in $\widetilde{L}_c(n, k\omega_1)$.

To establish that U resides in $\widetilde{L}_c(n, k\omega_1)$, we must demonstrate that the one-rowed tableau U meets the requirements for membership in $\widetilde{L}_c(n, k\omega_1)$, i.e. $1 \leq U_1 \leq \cdots \leq U_k \leq 2n$ unless $(U_i, U_{i+1}) = (n+1, n)$ for some $i \in \{1, 2, \dots, k-1\}$ where $U_{i-1} \leq n$ (if $1 \leq i-1$) and $U_{i+2} \geq n+1$ (if $i+2 \leq k$). Now, both S and T are in $\widetilde{L}_c(n, k\omega_1)$, which tells us that $1 \leq S_1$ and $1 \leq T_1$; thus $1 \leq U_1 = \min(S_1, T_1)$. Likewise, neither S_k nor T_k exceeds $2n$, so $U_k \leq 2n$. Let i be some index from the set $\{1, 2, \dots, k-1\}$. Without loss of generality, we may assume that $U_{i+1} = \min(S_{i+1}, T_{i+1})$ coincides with S_{i+1} , so $S_{i+1} \leq T_{i+1}$. Let us suppose for the moment that $S_i \leq S_{i+1}$. Since $U_i \leq S_i \leq S_{i+1}$, then we have $U_i \leq U_{i+1}$. To conclude that U is in $\widetilde{L}_c(n, k\omega_1)$, it only remains to be shown that if $U_i > U_{i+1}$, then $U_i = n+1$, $U_{i+1} = n$, $U_{i-1} \leq n$ (if $i > 1$), and $U_{i+2} \geq n+1$ (if $i+1 < k$).

So, suppose $U_i > U_{i+1}$. Above, we showed that if $S_i \leq S_{i+1}$, then $U_i \leq U_{i+1}$. So it must be the case that $S_i > S_{i+1}$. This means that $S_i = n+1$, $S_{i+1} = n$, $S_{i-1} \leq n$ (if $i > 1$), and $S_{i+2} \geq n+1$ (if $i+1 < k$). Now if $U_i = T_i < S_i$, then the fact that $U_i > U_{i+1}$ implies that $S_{i+1} < T_i < S_i$. But the latter is impossible, since it would require $n < T_i < n+1$. We conclude that $U_i = S_i$. Therefore we know that $U_i = n+1$ and $U_{i+1} = n$. Also, if $i > 1$, note that $U_{i-1} \leq S_{i-1}$ and that $S_{i-1} \leq n$, hence $U_{i-1} \leq n$.

To complete the argument that $U \in \widetilde{L}_c(n, k\omega_1)$, we need to show that if $i+1 < k$, then $U_{i+2} \geq n+1$. Well, if $U_{i+2} = S_{i+2}$, we are done. So, assume that $U_{i+2} = T_{i+2} < S_{i+2}$. To show that $T_{i+2} \geq n+1$, we suppose otherwise and derive a contradiction. So, suppose that $T_{i+2} < n+1$. If $T_{i+2} = n$ and $T_{i+1} = n+1$, then by the defining properties of the $\widetilde{L}_c(n, k\omega_1)$ tableaux, T_i should be at most n ; but $T_i \geq U_i = n+1$ implies $T_i \geq n+1$, which is a contradiction. So we must have $T_{i+1} \leq T_{i+2} \leq n$. Together with the fact that $n = U_{i+1} \leq T_{i+1}$, we get $n \leq T_{i+1} \leq T_{i+2} \leq n$, hence $T_{i+1} = n = T_{i+2}$. If $T_i > n$, then we would have $T_i = n+1$, $T_{i+1} = n$, and therefore

$T_{i+2} \geq n+1$, contradicting $T_{i+2} = n$. So now $T_i \leq n$. But, $n+1 = U_i \leq T_i \leq n$, which is a contradiction. We conclude that $T_{i+2} \geq n+1$, which completes the argument that $U \in \widetilde{L}_c(n, k\omega_1)$.

A parallel argument establishes that $R = S \wedge T$ also resides in $\widetilde{L}_c(n, k\omega_1)$. Then, $\widetilde{L}_c(n, k\omega_1)$ is a distributive lattice in its given reverse-componentwise order.

We now verify that $L_c^{Mol}(n, k\omega_1)$ and $L_c^{RS}(n, k\omega_1)$ are closed under joins and meets within $\widetilde{L}_c(n, k\omega_1)$. To this end, first suppose that the foregoing S and T are actually members of $L_c^{Mol}(n, k\omega_1)$, and take $U := (\min\{S_i, T_i\})_{i=1}^k = S \vee T$ in $L(n)^{\times k}$ as before. We already know that $U \in \widetilde{L}_c(n, k\omega_1)$, so to conclude that $U \in L_c^{Mol}(n, k\omega_1)$ we must show that $U_i \leq U_{i+1}$ whenever $i \in \{1, 2, \dots, k-1\}$. For such an i , suppose without loss of generality that $U_i = \min\{S_i, T_i\} = S_i$. If $U_{i+1} = S_{i+1}$, then we have $U_i = S_i \leq S_{i+1} \leq U_{i+1}$, and we are done. If $U_{i+1} = T_{i+1}$, then we have $U_i = S_i \leq S_{i+1} \leq T_{i+1} = U_{i+1}$, and we are done. Either way, $U \in L_c^{Mol}(n, k\omega_1)$. Similarly see that $R := (\min\{S_i, T_i\})_{i=1}^k = S \vee T \in L(n)^{\times k}$ also resides in $L_c^{Mol}(n, k\omega_1)$.

Next, take S, T , and U as before but with $S, T \in L_c^{RS}(n, k\omega_1)$. We already know that $U \in \widetilde{L}_c(n, k\omega_1)$, so to conclude that $U \in L_c^{RS}(n, k\omega_1)$ we must show that if $U_1 = 1$ then $U_k < 2n$. Well, suppose without loss of generality that $U_1 = \min\{S_1, T_1\} = S_1 = 1$. If $U_k = S_k$, then we have $U_k = S_k < 2n$, and we are done. If $U_k = T_k$, then we have $U_k = T_k \leq S_k < 2n$, and we are done. Either way, $U \in L_c^{RS}(n, k\omega_1)$. Similarly see that $R := (\min\{S_i, T_i\})_{i=1}^k = S \vee T \in L(n)^{\times k}$ also resides in $L_c^{RS}(n, k\omega_1)$. This completes the closure arguments for $\widetilde{L}_c(n, k\omega_1)$, $L_c^{Mol}(n, k\omega_1)$, and $L_c^{RS}(n, k\omega_1)$.

Let $X := \mathbf{min}(L(n)^{\times k}) = (2n, 2n, \dots, 2n)$ and $Y := \mathbf{max}(L(n)^{\times k}) = (1, 1, \dots, 1)$, which are also respectively the unique minimal (maximal) element of $\widetilde{L}_c(n, k\omega_1)$, $L_c^{Mol}(n, k\omega_1)$, and $L_c^{RS}(n, k\omega_1)$. To prove that $\widetilde{L}_c(n, k\omega_1)$ is full-length in $L(n)^{\times k}$ and that $L_c^{Mol}(n, k\omega_1)$ and $L_c^{RS}(n, k\omega_1)$ are full-length in $\widetilde{L}_c(n, k\omega_1)$, it suffices to find a path from X up to Y that stays entirely within $\widetilde{L}_c(n, k\omega_1)$, $L_c^{Mol}(n, k\omega_1)$, and $L_c^{RS}(n, k\omega_1)$. We do so as follows: In X , first change all $2n$'s to $(2n-1)$'s, working from the leftmost

entry of X to the rightmost. In the same way change all $(2n-1)$'s of the resulting one-rowed tableau to $(2n-2)$'s, again working from left to right. Continue this process until obtaining a one-rowed tableau of 2's. Change these 2's to 1's from left to right, thus arriving at Y . Thus we see that $\widetilde{L}_c(n, k\omega_1)$, $L_c^{Mol}(n, k\omega_1)$, and $L_c^{RS}(n, k\omega_1)$ have the same length as $L(n)^{\times k}$ and are therefore full-length (distributive) sublattices. With respect to the edge coloring inherited from $L(n)^{\times k}$, each of these distributive sublattices is diamond-colored. \square

Theorem 3.2 *Let L be any one of $\widetilde{L}_c(n, k\omega_1)$, $L_c^{RS}(n, k\omega_1)$, or $L_c^{Mol}(n, k\omega_1)$. Then:*

(1) *If $T = (T_1, \dots, T_k)$ is a one-rowed tableau from L , we have*

$$\begin{aligned} wt(T) = & \left(\#(T, 1) - \#(T, 2) + \#(T, 2n-1) - \#(T, 2n), \dots, \#(T, i) - \#(T, i+1) \right. \\ & + \#(T, 2n-i) - \#(T, 2n+1-i), \dots, \#(T, n-1) - \#(T, n) \\ & \left. + \#(T, n+1) - \#(T, n+2), \#(T, n) - \#(T, n+1) \right). \end{aligned}$$

(2) *L is C_n -structured.*

(3) *There exists a weight-preserving bijection $\varphi : L_c^{RS}(n, k\omega_1) \longrightarrow L_c^{Mol}(n, k\omega_1)$, so that*

$$\text{WGF}(L_c^{RS}(n, k\omega_1); z_1, z_2, \dots, z_n) = \text{WGF}(L_c^{Mol}(n, k\omega_1); z_1, z_2, \dots, z_n).$$

Moreover, $\text{RGF}(L_c^{RS}(n, k\omega_1); q) = \text{RGF}(L_c^{Mol}(n, k\omega_1); q) = \binom{2n-1+k}{k}_q$.

Proof. We begin with a proof of (1), so take $T \in L$ as presented there. Assume at the moment that $1 \leq i < n$. In order to get an edge with color i below T , an entry in our one-rowed tableau must change from i to $i+1$ or from $2n-i$ to $2n+1-i$. This change-in-entry would decrease the rank by one but would increase the depth by one. To get to the top of the i -component, all $(2n+1-i)$ -entries from T can be made into $(2n-i)$ -entries, and then all $(i+1)$ -entries can be made into i -entries. Similarly, to get to the bottom of the i -component, all i -entries become $(i+1)$ -entries, and then $(2n-i)$ -entries become $(2n+1-i)$ -entries. With these moves performed as indicated, there is no violation of admissibility. So, $\rho_i(T)$ is the number of i -entries

plus $(2n-i)$ -entries, and $\delta_i(T)$ is the number of $(i+1)$ -entries plus $(2n+1-i)$ -entries. Thus, we have that

$$\begin{aligned}
i^{\text{th}}\text{-coordinate of } wt(T) &= \rho_i(T) - \delta_i(T) \\
&= \left(\#i's + \#(2n-i)'s \right) - \left(\#(i+1)'s + \#(2n+1-i)'s \right) \\
&= \left(\#i's - \#(i+1)'s \right) + \left(\#(2n-i)'s - \#(2n+1-i)'s \right)
\end{aligned} \tag{3.0.1}$$

When $i = n$, use similar reasoning to see that $\rho_n(T)$ is the number of n -entries and $\delta_n(T)$ is the number of $(n+1)$ -entries. Thus,

$$\begin{aligned}
n^{\text{th}}\text{-coordinate of } wt(T) &= \rho_n(T) - \delta_n(T) \\
&= \#n's - \#(n+1)'s
\end{aligned} \tag{3.0.2}$$

Therefore, $wt(T)$ can be calculated in terms of its entries as indicated in part (1) of the theorem statement.

For (2), let A be the Cartan Matrix for the finitary GCM graph C_n . Consider an edge $S \xrightarrow{i} T$. For convenience, we let $m_j(X) := \rho_j(X) - \delta_j(X)$ for any color j and any tableau X . We wish to show that $m_j(T) - m_j(S) = (i, j)$ -entry of A if $i \neq j$.

We consider four separate cases: (i.) $|i-j| \geq 2$; (ii.) $|i-j| = 1$, $i < n$, and $j < n$; (iii.) $i = n-1$ and $j = n$; and (iv.) $i = n$ and $j = n-1$.

Proof of (i.): Suppose $|i-j| \geq 2$, where i is the color-component and j is the j -coordinate of $wt(t)$. T is formed from S by changing one entry of S . This change will affect only the i -coordinate, $(i-1)$ -coordinate, or $(i+1)$ -coordinate in $wt(T)$. It goes to say that if $i = 1$, it will affect only i and $(i+1)$ -coordinates and if $i = n$, it will affect only i and $(i-1)$ -coordinates. Because $i \neq j$ and $|i-j| \geq 2$, it can be seen that $m_j(T) = m_j(S)$. Hence, $m_j(T) - m_j(S) = 0$.

Proof of (ii.): Suppose $|i-j| = 1$, $i < n$, and $j < n$.

Consider $j = i - 1$.

$$\begin{aligned}
m_{i-1}(T) - m_{i-1}(S) &= [\rho_{i-1}(T) - \delta_{i-1}(T)] - [\rho_{i-1}(S) - \delta_{i-1}(S)] \\
&= \rho_{i-1}(T) - \delta_{i-1}(T) - \rho_{i-1}(S) + \delta_{i-1}(S) \\
&= [\#(i-1)'s + \#(2n - (i-1))'s] - [\#i's + \#(2n - (i-2))'s] \\
&\quad - [\#(i-1)'s + \#(2n - (i-1))'s] + [\#i's + \#(2n - (i-2))'s - 1] \\
&= -1
\end{aligned} \tag{3.0.3}$$

The one entry of i or $2n - i + 2$ changing will decrease the depth of S at it's $(i-1)$ -component by one.

Similarly, consider $j = i + 1$.

$$\begin{aligned}
m_{i+1}(T) - m_{i+1}(S) &= [\rho_{i+1}(T) - \delta_{i+1}(T)] - [\rho_{i+1}(S) - \delta_{i+1}(S)] \\
&= \rho_{i+1}(T) - \delta_{i+1}(T) - \rho_{i+1}(S) + \delta_{i+1}(S) \\
&= [\#(i+1)'s + \#(2n - (i+1))'s] - [\#(i+2)'s + \#(2n - (i+2))'s] \\
&\quad - [\#(i+1)'s + \#(2n - (i+1))'s + 1] + [\#(i+2)'s + \#(2n - (i+2))'s] \\
&= -1
\end{aligned} \tag{3.0.4}$$

This time, the entry change will increase the rank of S at it's $(i+1)$ -component by one.

Proof of (iii.): Suppose $i = n - 1$ and $j = n$.

$$\begin{aligned}
m_n(T) - m_n(S) &= [\rho_n(T) - \delta_n(T)] - [\rho_n(S) - \delta_n(S)] \\
&= \rho_n(T) - \delta_n(T) - \rho_n(S) + \delta_n(S) \\
&= \#n's - \#(n+1)'s - (\#n's + 1) + \#(n+1)'s \\
&= -1
\end{aligned} \tag{3.0.5}$$

An $(n-1)$ -entry will change to n . So, the rank of S at it's n -component will increase by 1.

Proof of (iv.): Suppose $i = n$ and $j = n - 1$.

$$\begin{aligned}
m_{n-1}(T) - m_{n-1}(S) &= [\rho_{n-1}(T) - \delta_{n-1}(T)] - [\rho_{n-1}(S) - \delta_{n-1}(S)] \\
&= \rho_{n-1}(T) - \delta_{n-1}(T) - \rho_{n-1}(S) + \delta_{n-1}(S) \\
&= [\#(n-1)'s + \#(n+1)'s] - [\#n's + \#(n+2)'s] \\
&\quad - [\#(n-1)'s + \#(n+1)'s + 1] + [\#n's - 1 + \#(n+2)'s] \\
&= -2
\end{aligned} \tag{3.0.6}$$

An n -entry will change to $n+1$. The rank of S at it's $(n-1)$ -component will increase by 1, and the depth of S at it's $(n-1)$ -component will decrease by 1. This completes the analysis of the last of our four cases and, thus, completes the proof of part (2) of the theorem statement.

For (3), we produce a bijection $L_C^{Mol} \xrightarrow{\sim} L_C^{RS}$ as follows.

- (i.) First, we define $\psi: L_C^{Mol}(n, k\omega_1) \rightarrow L_C^{RS}(n, k\omega_1)$. In particular, for a tableau T from $L_C^{Mol}(n, k\omega_1)$, build $\psi(T)$ as follows: where entries in T transition from $\boxed{\leq n}$ to $\boxed{\geq n+1}$, insert an $\boxed{n+1} \mid \boxed{n}$ pair each time a $\boxed{1} \mid \dots \mid \boxed{2n}$ pair is removed. Repeat this until there are no $\boxed{1} \mid \dots \mid \boxed{2n}$ pairs left.

(ii.) Second, we define $\varphi: L_c^{RS}(n, k\omega_1) \rightarrow L_c^{Mol}(n, k\omega_1)$. Build $\varphi(T)$ from T as follows: each $\begin{array}{|c|c|} \hline n+1 & n \\ \hline \end{array}$ is replaced with a $\begin{array}{|c|c|c|} \hline 1 & \dots & 2n \\ \hline \end{array}$ and repeated until no $\begin{array}{|c|c|} \hline n+1 & n \\ \hline \end{array}$'s are left.

It is evident that $\varphi \circ \psi: L_c^{Mol} \rightarrow L_c^{Mol}$ is the identity mapping, as well as $\psi \circ \varphi: L_c^{RS} \rightarrow L_c^{RS}$. Therefore, each of ψ and φ is a bijection, with $\varphi^{-1} = \psi$ and $\psi^{-1} = \varphi$. Observe that $m_i(\psi(T)) = m_i(T)$ when $1 < i < n$ because none of the entries 2 through $n-1$ and $n+2$ through $2n-1$ are affected by ψ . Similarly, see that $m_i(\varphi(T)) = m_i(T)$ for such i . So, our only potential concern is when $i = 1$ or $i = n$.

Now, when $i = 1$, it can be seen that

$$\begin{aligned} (\#1's - \#2's) + (\#(2n-1)'s - \#(2n)'s) &= (\#1's - 1 - \#2's) + (\#(2n-1)'s - (\#(2n)'s - 1)) \\ &= (\#1's + 1 - \#2's) + (\#(2n-1)'s - (\#(2n)'s + 1)). \end{aligned} \tag{3.0.7}$$

And when $i = n$, it can be seen that

$$\begin{aligned} \#n's - \#(n+1)'s &= (\#n's + 1) - (\#(n+1)'s + 1) \\ &= (\#n's - 1) - (\#(n+1)'s - 1). \end{aligned} \tag{3.0.8}$$

Thus, $m_i(\psi(T)) = m_i(T)$ when $i = 1$ or when $i = n$. Similarly, $m_i(\varphi(T)) = m_i(T)$ when $i = 1$ or when $i = n$. Therefore, $wt(\psi(T)) = wt(T)$ and $wt(\varphi(T)) = wt(T)$. So, ψ and φ are weight-preserving. This completes the proof of part (3) of the theorem.

□

Chapter 4

Some algebraic context

In this chapter, we further (but briefly) discuss some of the connections between our type C one-rowed lattices and various algebraic structures. This discussion mostly consists of some follow-up to various claims and comments throughout the thesis relating to the potential of our type C one-rowed lattices as models for certain type C Weyl symmetric functions. For a more thorough treatment of these ideas, see [Don3]. Here, we begin with a recapitulation of some general principles from [Don3] that is rooted in language from Chapters 1 and 2 above.

For a type X_n finitary GCM graph, the associated Weyl group $W(X_n)$ is finite and there exist non-constant X_n -symmetric functions. Moreover, the ring/ \mathbb{Z} -module of X_n -symmetric functions has as a \mathbb{Z} -basis a distinguished set of Weyl symmetric functions denoted $\{\chi_\lambda^{X_n}\}$ indexed by the dominant weights in Λ . The latter have been termed *Weyl bialternants* because they can be expressed as quotients of certain sign-alternating functions. In type A, the Weyl bialternants are famously known as the “Schur functions” of classical symmetric function theory, so each $\chi_\lambda^{X_n}$ can be regarded as an X_n -analog of a Schur function.

Here we briefly explore some of the many natural interactions between Weyl symmetric functions and order-theoretic / enumerative combinatorics. The following

demonstrations will showcase the importance of the \mathbf{X}_n -structure property. To begin, let us suppose that R is an \mathbf{X}_n -structured poset whose i -components are rank symmetric. For a fixed color i , label the distinct i -components $\mathcal{C}_1^{(i)}, \dots, \mathcal{C}_{k_i}^{(i)}$, and regard R to be the disjoint sum $\mathcal{C}_1^{(i)} \oplus \dots \oplus \mathcal{C}_{k_i}^{(i)}$. Now let $\tau_j^{(i)}$ be some pairing of the elements within an i -component $\mathcal{C}_j^{(i)}$ such that $\delta_i(\tau_j^{(i)}(\mathbf{x})) = \rho_i(\mathbf{x})$ for each $\mathbf{x} \in \mathcal{C}_j^{(i)}$, which is possible since $\mathcal{C}_j^{(i)}$ is rank symmetric. For such \mathbf{x} , observe that since R is \mathbf{X}_n -structured we have $wt(\tau_j^{(i)}(\mathbf{x})) = wt(\mathbf{x}) - (\rho_i(\mathbf{x}) - \delta_i(\mathbf{x}))\alpha_i$. Now let $\tau^{(i)} : R \rightarrow R$ be the bijection defined by $\tau^{(i)}(\mathbf{x}) := \tau_j^{(i)}(\mathbf{x})$ when $\mathbf{x} \in \mathcal{C}_j^{(i)}$. Then:

$$\begin{aligned}
S_i.\text{WGF}(R; z_1, \dots, z_n) &= S_i. \sum_{\mathbf{x} \in R} z^{wt(\mathbf{x})} \\
&= \sum_{\mathbf{x} \in R} S_i. z^{wt(\mathbf{x})} \\
&= \sum_{\mathbf{x} \in R} z^{S_i(wt(\mathbf{x}))} \\
&= \sum_{\mathbf{x} \in R} z^{wt(\mathbf{x}) - (\rho_i(\mathbf{x}) - \delta_i(\mathbf{x}))\alpha_i} \\
&= \sum_{\tau^{(i)}(\mathbf{x}) \in R} z^{wt(\tau^{(i)}(\mathbf{x})) - (\rho_i(\tau^{(i)}(\mathbf{x})) - \delta_i(\tau^{(i)}(\mathbf{x})))\alpha_i} \\
&= \sum_{\mathbf{x} \in R} z^{wt(\tau^{(i)}(\mathbf{x})) - (\rho_i(\tau^{(i)}(\mathbf{x})) - \delta_i(\tau^{(i)}(\mathbf{x})))\alpha_i} \\
&= \sum_{\mathbf{x} \in R} z^{wt(\tau^{(i)}(\mathbf{x})) + (\rho_i(\mathbf{x}) - \delta_i(\mathbf{x}))\alpha_i} \\
&= \sum_{\mathbf{x} \in R} z^{wt(\mathbf{x}) - (\rho_i(\mathbf{x}) - \delta_i(\mathbf{x}))\alpha_i + (\rho_i(\mathbf{x}) - \delta_i(\mathbf{x}))\alpha_i} \\
&= \sum_{\mathbf{x} \in R} z^{wt(\mathbf{x})} \\
&= \text{WGF}(R; z_1, \dots, z_n)
\end{aligned}$$

Since the preceding computation works for any color i , we conclude that $\text{WGF}(R; z_1, \dots, z_n)$ is $W(\mathbf{X}_n)$ -invariant.

Suppose now that an \mathbf{X}_n -structured poset R is connected. For $\mathbf{s}, \mathbf{t} \in R$, suppose that $wt(\mathbf{s}) = wt(\mathbf{t})$. Let $(\mathbf{s} = \mathbf{x}_0, \mathbf{x}_1, \dots, \mathbf{x}_p = \mathbf{t})$ be a sequence of elements in R

such that for $1 \leq j \leq p$ there is a color i_j for which either $\mathbf{x}_{j-1} \xrightarrow{i_j} \mathbf{x}_j$ or $\mathbf{x}_j \xrightarrow{i_j} \mathbf{x}_{j-1}$. We think of this sequence as a path \mathcal{P} from \mathbf{s} to \mathbf{t} . For a fixed color i , let $u_i := |\{j \in \{1, \dots, p\} \mid \mathbf{x}_{j-1} \xrightarrow{i} \mathbf{x}_j\}|$, which is, informally speaking, the number of times an ‘upward’ edge of color i appears within our path \mathcal{P} . Similarly let $d_i := |\{j \in \{1, \dots, p\} \mid \mathbf{x}_j \xrightarrow{i} \mathbf{x}_{j-1}\}|$ be the number of times a ‘downward’ edge of color i appears in \mathcal{P} . From the X_n -structure property, we have

$$wt(\mathbf{s}) + \sum_{i=1}^n (u_i - d_i)\alpha_i = wt(\mathbf{t}).$$

Since $wt(\mathbf{s}) = wt(\mathbf{t})$, then $\sum_{i=1}^n (u_i - d_i)\alpha_i = 0$, where the latter is the zero vector. It is easy to check that the Cartan matrix for any finitary GCM graph is invertible and hence its rows are linearly independent. This forces the scalar coefficient $u_i - d_i$ to be 0 for each i , i.e. $u_i = d_i$ for each i . Thus \mathbf{s} and \mathbf{t} have the same rank within R . In particular, it is this reasoning allows us to deduce that $L_C^{Mol}(n, k\omega_1)$ and $L_C^{RS}(n, k\omega_1)$ have the same rank generating function given that both are C_n -structured and that there is a one-to-one weight-preserving correspondence between their elements.

In general, if R is X_n -structured and $\text{WGF}(R; z_1, \dots, z_n)$ is the X_n -Weyl bialternant corresponding to some dominant weight λ , then we say R is a *splitting poset* for $\chi_\lambda^{X_n}$. When such an R is connected, then it can be seen that R is rank symmetric and rank unimodal and that its rank generating function $\text{RGF}(R; q)$ is a quotient of products of q -integers, cf. Proposition 4.7 of [Don3].

With these general notions in mind, we would like to place the results of this thesis within a programmatic context. The Weyl symmetric functions $\{\chi_{\omega_k}^{X_n}\}_{k \in I}$ associated to the fundamental weights $\{\omega_k\}_{k \in I}$ are called *elementary* Weyl symmetric functions; in type A_n , these are just the elementary symmetric functions of classical symmetric function theory. Splitting modular (in fact distributive) lattices for the elementary Weyl symmetric functions have been found for types A, B, and C. These lattices seem

to be the “right” models in terms of their interrelationships, extremal properties, etc (see [Don1] for a more precise development of these notions). Notably, however, such models for the type D elementary Weyl symmetric functions have not been found. This is perhaps the most prominent outstanding problem in the nascent theory of splitting modular/distributive lattices espoused in [Don3]. See Table 1.1 of that paper for a comprehensive summary of what is currently known about splitting modular/distributive lattices.

In the so-called classical cases – where X is one of A, B, C, or D – the Weyl bialternants $\{\chi_{k\omega_1}^{X_n}\}_{k=1,2,3,\dots}$ are called *one-rowed* Weyl symmetric functions because of their close connections to certain one-rowed tableaux. Splitting modular (in fact distributive) lattices for the one-rowed Weyl-symmetric functions that seem “right” (in the above sense of this word) have been found for types A and B. In type A, these are just the type A one-rowed lattices of Chapter 2. In type B, these are the Molev and RS one-rowed lattices from [DLP1] and presented above in Chapter 2. This thesis proposes what seems to be the right one-rowed solutions in type C, namely the Molev and RS one-rowed lattices of Chapter 3. There exist distributive lattice models that are type D analogs of the type B and C Molev one-rowed lattices; another prominent outstanding problem is to find type D lattices that analogize the RS one-rowed lattices of types B and C.

Note, however, that we have not *formally* demonstrated in this thesis that the Molev and RS type C_n one-rowed lattices are splitting distributive lattices for the one-rowed Weyl bialternants $\{\chi_{k\omega_1}^{C_n}\}_{k=1,2,3,\dots}$, nor have we *formally* established here that their weight-generating functions are $W(C_n)$ -invariant. But consider the following: It is observed in [ADLP1] that $L_C^{Mol}(n, k\omega_1)$ is (to borrow some Lie theoretic language from §4 of [Don3]) a supporting graph for the irreducible representation of the simple complex symplectic Lie algebra of type C_n whose dominant weight is $k\omega_1$. It follows immediately from Proposition 4.18 of [Don3] that $L_C^{Mol}(n, k\omega_1)$ is a splitting

distributive lattice for $\chi_{k\omega_1}^{C_n}$. Then from our main result (Theorem 3.2) it follows that $L_C^{RS}(n, k\omega_1)$ is also a splitting distributive lattice for $\chi_{k\omega_1}^{C_n}$.

Still, we are interested in finding a proof of this splitting result that does not depend on Lie algebra representation theory. Such non-Lie-theoretic approaches can be found in §8 of [Don3] (which establishes splitting results for type B, C, and D Weyl bialternants whose highest weight is a multiple of a ‘right-end-node’ fundamental weight), in [ADLP2] (which uniformly establishes splitting results for all X_2 -Weyl symmetric functions when $X \in \{A, C, G\}$), and in Chapter 5 of [Beck] (which establishes splitting results for the elementary Weyl symmetric functions in type B). Each of these foregoing results is an application of Theorem 8.1 of [Don3]. To facilitate such a proof for our type C one-rowed lattices, a careful analysis of the i -components of $L_C^{Mol}(n, k\omega_1)$ and $L_C^{RS}(n, k\omega_1)$ is required. Based on our investigation of cases for small n and k , we believe that all i -components of the type C one-rowed lattices are products of chains. This is a desirable property, as it implies rank symmetry of all i -components and satisfies one of the criteria of Theorem 8.1 of [Don3]. However, in type B, there exists at least one n -component of $L_B^{RS}(n, k\omega_1)$ that is *not* a product of chains whenever $k \geq 2$; when $n = k = 2$, one can observe this phenomenon directly by inspecting $L_B^{RS}(2, 2\omega_1)$ in Figure 1.2 from Chapter 1 above. So, our tentative claim above – that all i -components of $L_C^{Mol}(n, k\omega_1)$ and $L_C^{RS}(n, k\omega_1)$ are products of chains – is not automatic.

Next, we concretely illustrate some the main ideas of this thesis using the finitary GCM graph C_2 . The Cartan matrix for C_2 is $\begin{pmatrix} 2 & -1 \\ -2 & 2 \end{pmatrix}$. Then α_1 is the row vector $(2, -1)$ and α_2 is the row vector $(-2, 2)$. We identify the lattice of weights Λ with the \mathbb{Z} -module $\mathbb{Z} \oplus \mathbb{Z}$, so weights are just pairs of integers.

Now $S_1 : \Lambda \rightarrow \Lambda$ is defined as $S_1(\mu) := \mu - a\alpha_1$ when $\mu = (a, b)$. So, $S_1(a, b) = (a, b) - a(2, -1) = (-a, a + b)$, which is exactly the NNG node-firing move associated with node γ_1 of the C_2 GCM graph, cf. Figure 2.2. Similarly $S_2 : \Lambda \rightarrow \Lambda$ is defined

as $S_2(\mu) := \mu - b\alpha_2$ when $\mu = (a, b)$. So, $S_2(a, b) = (a, b) - b(-2, 2) = (a + 2b, -b)$, which is exactly the NNG node-firing move associated with node γ_2 of the C_2 GCM graph. What follows below are further concrete viewpoints of S_1 and S_2 .

$$S_1 = \begin{bmatrix} -1 & 0 \\ 1 & 1 \end{bmatrix} \quad S_2 = \begin{bmatrix} 1 & 2 \\ 0 & -1 \end{bmatrix}$$

$$\begin{bmatrix} -1 & 0 \\ 1 & 1 \end{bmatrix} \cdot \begin{bmatrix} a \\ b \end{bmatrix} = \begin{bmatrix} -a \\ a + b \end{bmatrix}$$

$$\begin{bmatrix} 1 & 2 \\ 0 & -1 \end{bmatrix} \cdot \begin{bmatrix} a \\ b \end{bmatrix} = \begin{bmatrix} a + 2b \\ -b \end{bmatrix}$$

With these matrices, it is easy to check that $S_1^2 = S_2^2 = \varepsilon$ and $S_1 S_2 S_1 S_2 = S_2 S_1 S_2 S_1$.

Moreover, here is how S_1 and S_2 act on Laurent monomials:

$$S_1 \cdot (z_1^a z_2^b) = z_1^{-a} z_2^{a+b}$$

$$S_2 \cdot (z_1^a z_2^b) = z_1^{a+2b} z_2^{-b}$$

The 8-element dihedral group D_4 has the following well-known presentation by (abstract) generators s_1, s_2 and relations:

$$D_4 \cong \langle s_1, s_2 \mid s_1^2 = s_2^2 = \varepsilon, s_1 s_2 s_1 s_2 = s_2 s_1 s_2 s_1 \rangle.$$

Its elements are $\{\varepsilon, s_1, s_2, s_1 s_2, s_2 s_1, s_1 s_2 s_1, s_2 s_1 s_2, s_1 s_2 s_1 s_2\}$. So our strategy for showing that $W(\mathbb{C}_2) \cong D_4$ is to show that our S_1 and S_2 , viewed as matrices, satisfy the above D_4 relations and generate at least 8 distinct 2×2 matrices when we consider all possible products of our S_1 's and S_2 's. The computations below confirm that we get at least 8 distinct matrices, as desired:

$$\begin{array}{c} a \quad b \\ \bullet \quad \bullet \\ \leftarrow \quad \leftarrow \\ \gamma_1 \quad \gamma_2 \end{array}$$

$$(a) \varepsilon(a, b) = (a, b)$$

$$\begin{array}{c} -a \quad a+b \\ \bullet \quad \bullet \\ \leftarrow \quad \leftarrow \\ \gamma_1 \quad \gamma_2 \end{array}$$

$$(b) S_1(a, b) = (-a, a+b)$$

$$\begin{array}{c} a+2b \quad -b \\ \bullet \quad \bullet \\ \leftarrow \quad \leftarrow \\ \gamma_1 \quad \gamma_2 \end{array}$$

$$(c) S_2(a, b) = (a+2b, -b)$$

$$\begin{array}{c} -a-2b \quad a+b \\ \bullet \quad \bullet \\ \leftarrow \quad \leftarrow \\ \gamma_1 \quad \gamma_2 \end{array}$$

$$(d) S_1 S_2(a, b) = (-a-2b, a+b)$$

$$\begin{array}{c} a+2b \quad -a-b \\ \bullet \quad \bullet \\ \leftarrow \quad \leftarrow \\ \gamma_1 \quad \gamma_2 \end{array}$$

$$(e) S_2 S_1(a, b) = (a+2b, -a-b)$$

$$\begin{array}{c} -a-2b \quad b \\ \bullet \quad \bullet \\ \leftarrow \quad \leftarrow \\ \gamma_1 \quad \gamma_2 \end{array}$$

$$(f) S_1 S_2 S_1(a, b) = (-a-2b, b)$$

$$\begin{array}{c} a \quad -a-b \\ \bullet \quad \bullet \\ \leftarrow \quad \leftarrow \\ \gamma_1 \quad \gamma_2 \end{array}$$

$$(g) S_2 S_1 S_2(a, b) = (a, -a-b)$$

$$\begin{array}{c} -a \quad -b \\ \bullet \quad \bullet \\ \leftarrow \quad \leftarrow \\ \gamma_1 \quad \gamma_2 \end{array}$$

$$(h) S_1 S_2 S_1 S_2(a, b) = (-a, -b)$$

On the following pages, we showcase some small examples of our type C one-rowed lattices along with some weight-generating function calculations.

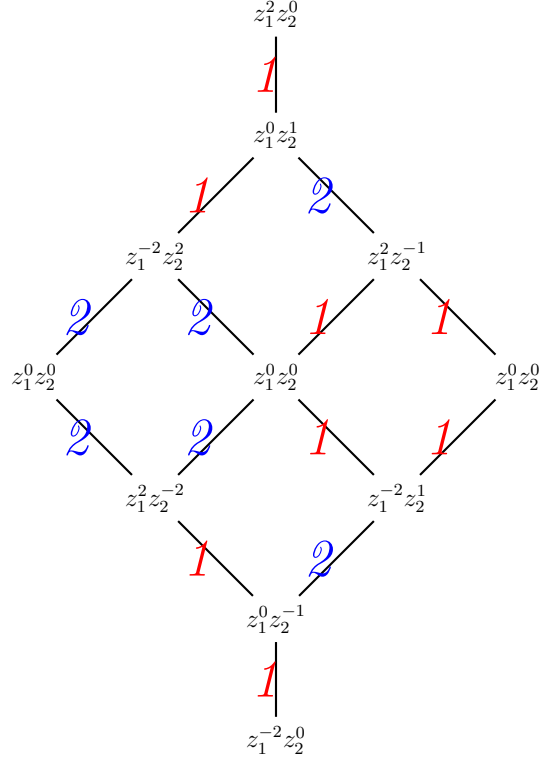
Figure 4.0.2: $\widetilde{L}_C(2, 2\omega_1)$

$$\text{WGF}(\widetilde{L}_C(2, 2\omega_1)); z_1, z_2) =$$

$$z_1^2 z_2^0 + z_1^0 z_2^1 + z_1^{-2} z_2^2 + z_1^2 z_2^{-1} + z_1^0 z_2^0 + z_1^0 z_2^0 + z_1^0 z_2^0 + z_1^2 z_2^{-2} + z_1^{-2} z_2^1 + z_1^0 z_2^{-1} + z_1^{-2} z_2^0$$

$$S_1.\text{WGF}(\widetilde{L}_C(2, 2\omega_1)); z_1, z_2) =$$

$$z_1^{-2} z_2^2 + z_1^0 z_2^1 + z_1^2 z_2^0 + z_1^{-2} z_2^1 + z_1^0 z_2^0 + z_1^0 z_2^0 + z_1^0 z_2^0 + z_1^{-2} z_2^0 + z_1^2 z_2^{-1} + z_1^0 z_2^{-1} + z_1^2 z_2^{-2}$$

$$S_2.\text{WGF}(\widetilde{L}_C(2, 2\omega_1)); z_1, z_2) =$$

$$z_1^2 z_2^0 + z_1^2 z_2^{-1} + z_1^2 z_2^{-2} + z_1^0 z_2^1 + z_1^0 z_2^0 + z_1^0 z_2^0 + z_1^0 z_2^0 + z_1^{-2} z_2^2 + z_1^0 z_2^{-1} + z_1^{-2} z_2^1 + z_1^{-2} z_2^0$$

$\text{WGF}(\widetilde{L}_C(2, 2\omega_1); z_1, z_2)$ is $W(C_2)$ -invariant.

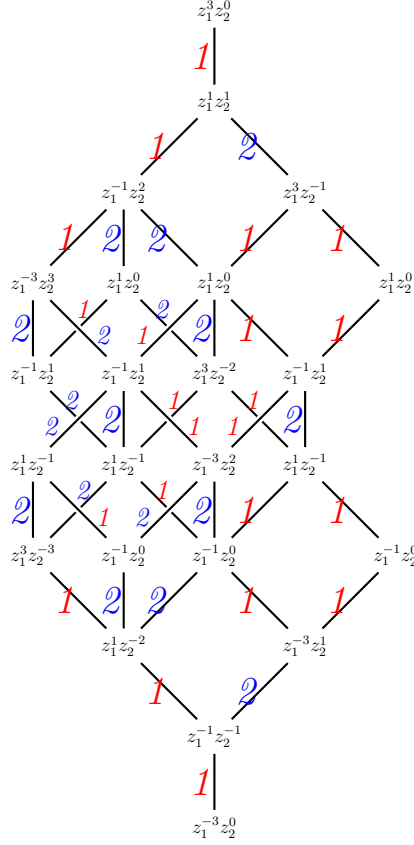
(a) $\widetilde{L}_C(2, 3\omega_1)$

$$\begin{aligned} \text{WGF}(\widetilde{L}_C(2, 3\omega_1)); z_1, z_2) &= z_1^3 z_2^0 + z_1^1 z_2^1 + z_1^{-1} z_2^2 + z_1^3 z_2^{-1} + z_1^{-3} z_2^3 + z_1^1 z_2^0 + z_1^1 z_2^0 + \\ & z_1^1 z_2^0 + z_1^{-1} z_2^1 + z_1^{-1} z_2^1 + z_1^3 z_2^{-2} + z_1^{-1} z_2^1 + z_1^1 z_2^{-1} + z_1^1 z_2^{-1} + z_1^{-3} z_2^2 + z_1^1 z_2^{-1} + z_1^3 z_2^{-3} + \\ & z_1^{-1} z_2^0 + z_1^{-1} z_2^0 + z_1^{-1} z_2^0 + z_1^1 z_2^{-2} + z_1^{-3} z_2^1 + z_1^{-1} z_2^{-1} + z_1^{-3} z_2^0 \end{aligned}$$

$$\begin{aligned} S_1.\text{WGF}(\widetilde{L}_C(2, 3\omega_1)); z_1, z_2) &= z_1^{-3} z_2^3 + z_1^{-1} z_2^2 + z_1^1 z_2^1 + z_1^{-3} z_2^2 + z_1^3 z_2^0 + z_1^{-1} z_2^1 + z_1^{-1} z_2^1 + \\ & z_1^{-1} z_2^1 + z_1^1 z_2^0 + z_1^1 z_2^0 + z_1^{-3} z_2^1 + z_1^1 z_2^0 + z_1^{-1} z_2^0 + z_1^{-1} z_2^0 + z_1^3 z_2^{-1} + z_1^{-1} z_2^0 + z_1^{-3} z_2^0 + \\ & z_1^1 z_2^{-1} + z_1^1 z_2^{-1} + z_1^1 z_2^{-1} + z_1^{-1} z_2^{-1} + z_1^3 z_2^{-2} + z_1^1 z_2^{-2} + z_1^3 z_2^{-3} \end{aligned}$$

$$\begin{aligned} S_2.\text{WGF}(\widetilde{L}_C(2, 3\omega_1)); z_1, z_2) &= z_1^3 z_2^0 + z_1^3 z_2^{-1} + z_1^3 z_2^{-2} + z_1^1 z_2^1 + z_1^3 z_2^{-3} + z_1^1 z_2^0 + z_1^1 z_2^0 + \\ & z_1^1 z_2^0 + z_1^1 z_2^{-1} + z_1^1 z_2^{-1} + z_1^{-1} z_2^2 + z_1^1 z_2^{-1} + z_1^{-1} z_2^1 + z_1^{-1} z_2^1 + z_1^1 z_2^{-2} + z_1^{-1} z_2^1 + z_1^{-3} z_2^3 + \\ & z_1^{-1} z_2^0 + z_1^{-1} z_2^0 + z_1^{-1} z_2^0 + z_1^{-3} z_2^2 + z_1^{-1} z_2^{-1} + z_1^{-3} z_2^1 + z_1^{-3} z_2^0 \end{aligned}$$

$\text{WGF}(\widetilde{L}_C(2, 3\omega_1); z_1, z_2)$ is $W(C_2)$ -invariant.

Chapter 5

A gallery of type **C** examples

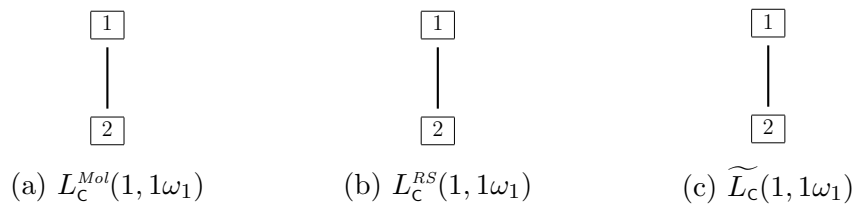

Figure 5.0.1: Molev, Reiner-Stanton, and Tilde graphs with $n = k = 1$.

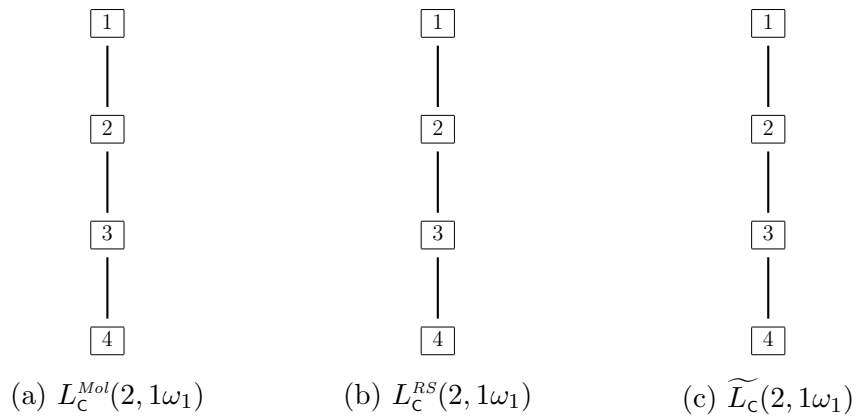
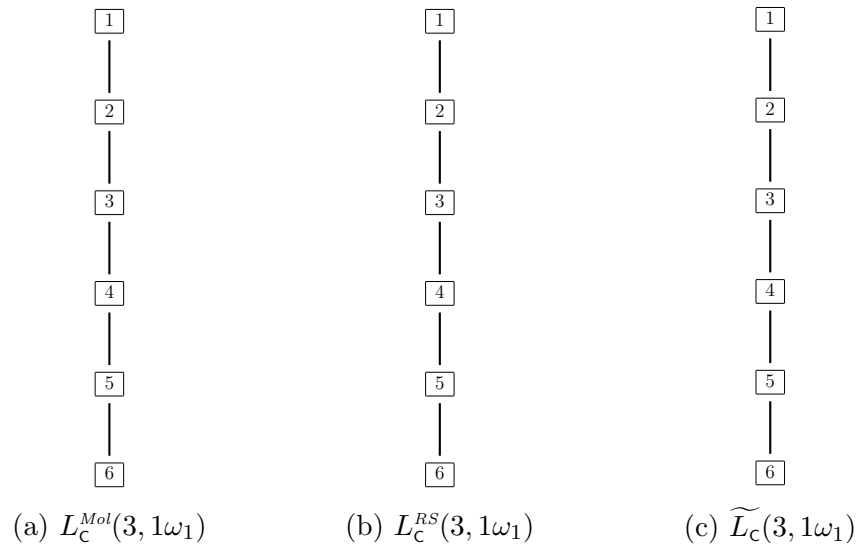
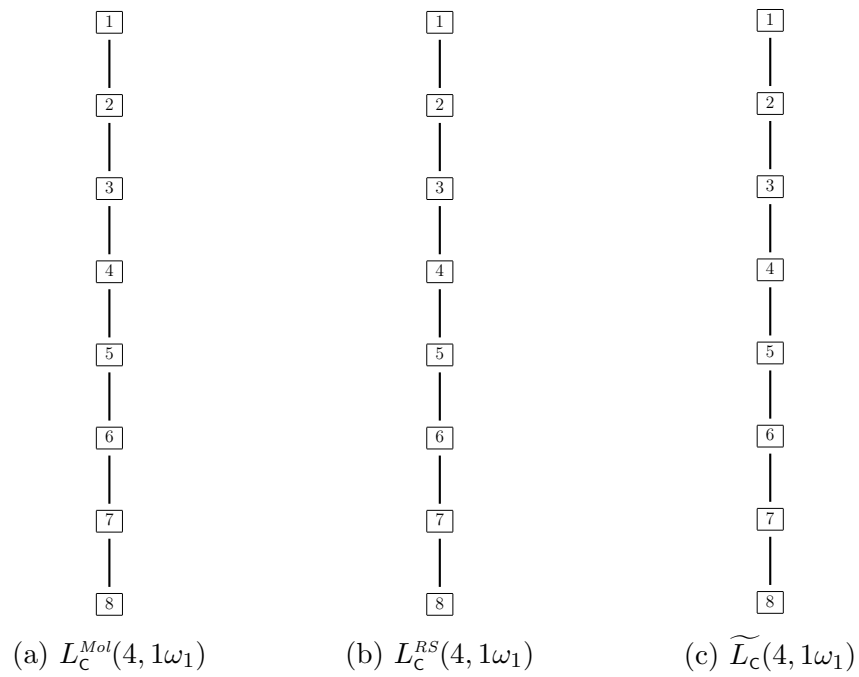

Figure 5.0.2: Molev, Reiner-Stanton, and Tilde graphs with $n = 2$ and $k = 1$.

Figure 5.0.3: Molev, Reiner-Stanton, and Tilde graphs with $n = 3$ and $k = 1$.Figure 5.0.4: Molev, Reiner-Stanton, and Tilde graphs with $n = 4$ and $k = 1$.

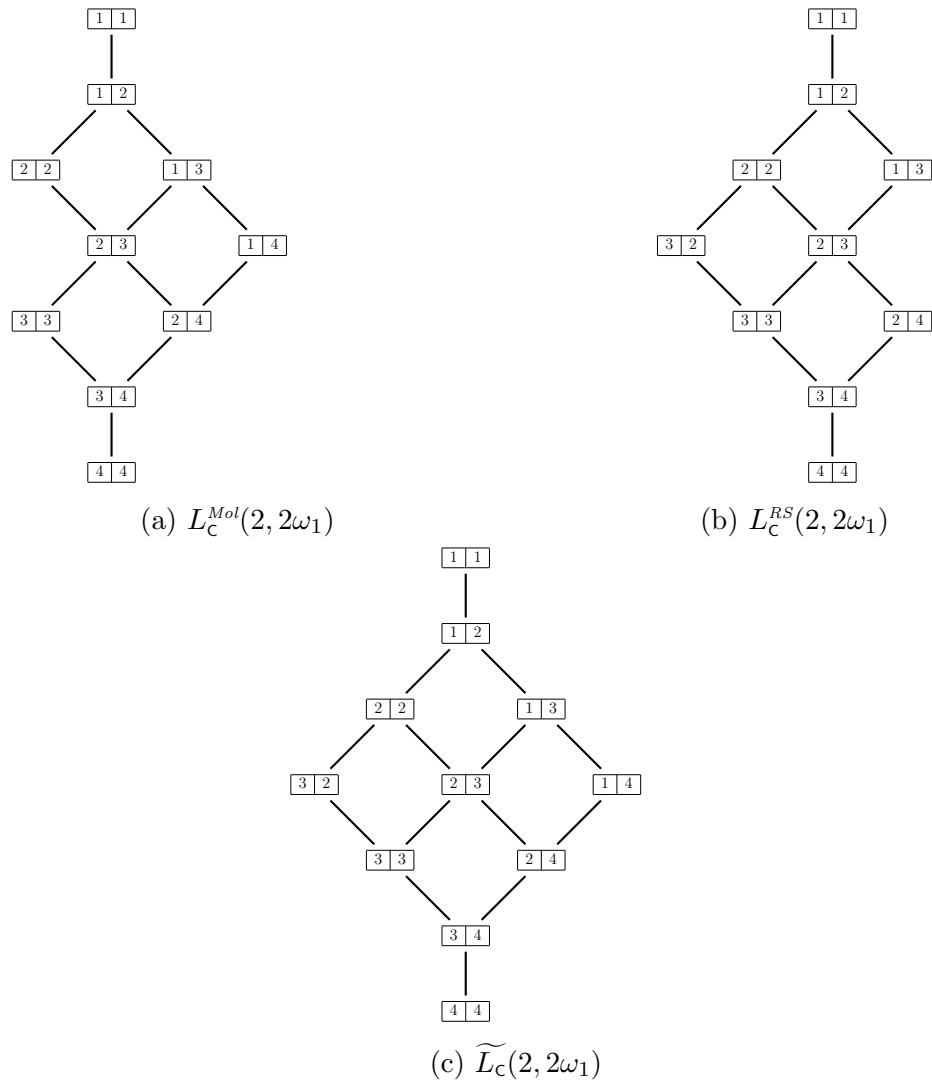

Figure 5.0.5: Molev, Reiner-Stanton, and Tilde graphs with $n = 2$ and $k = 2$.

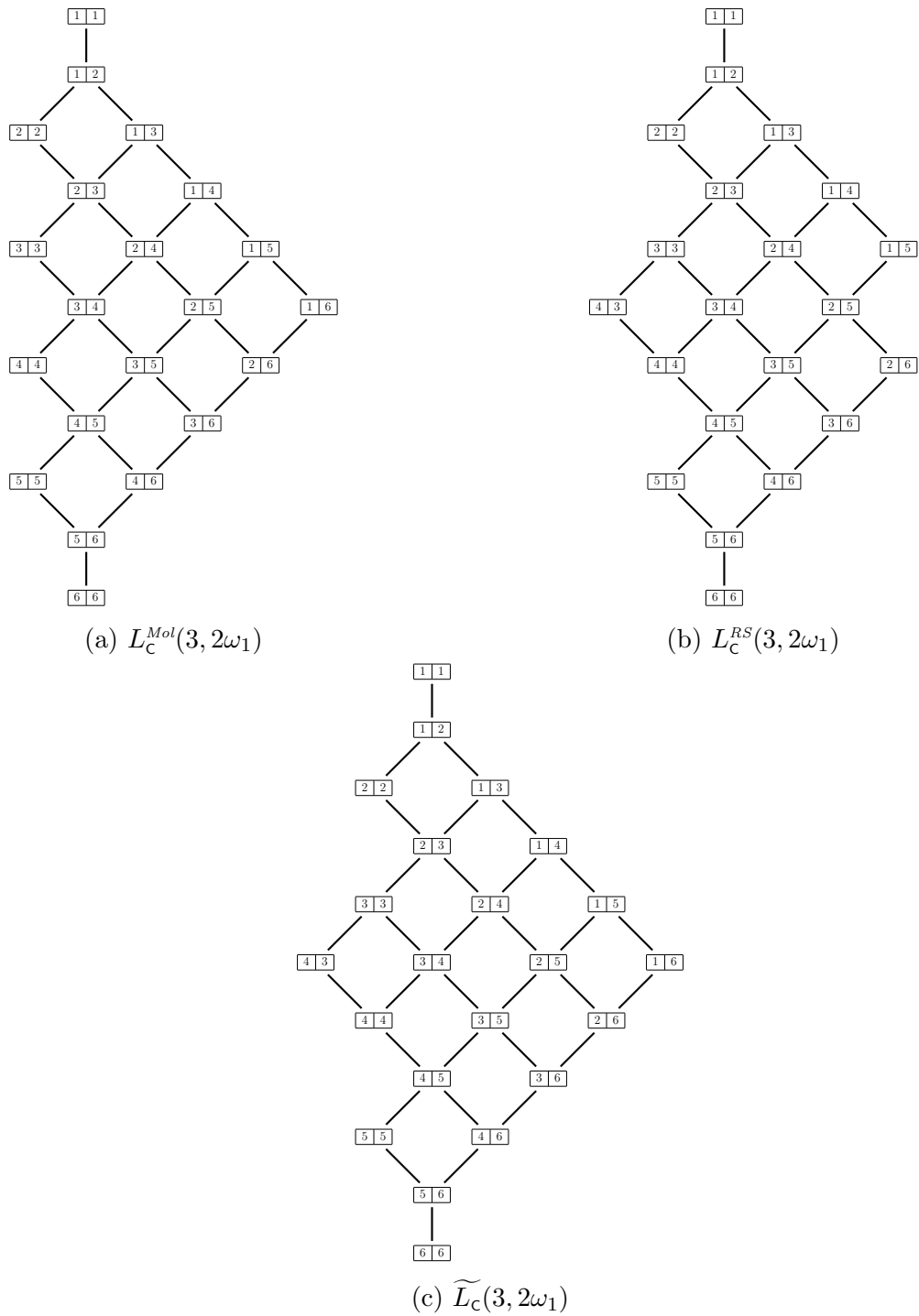
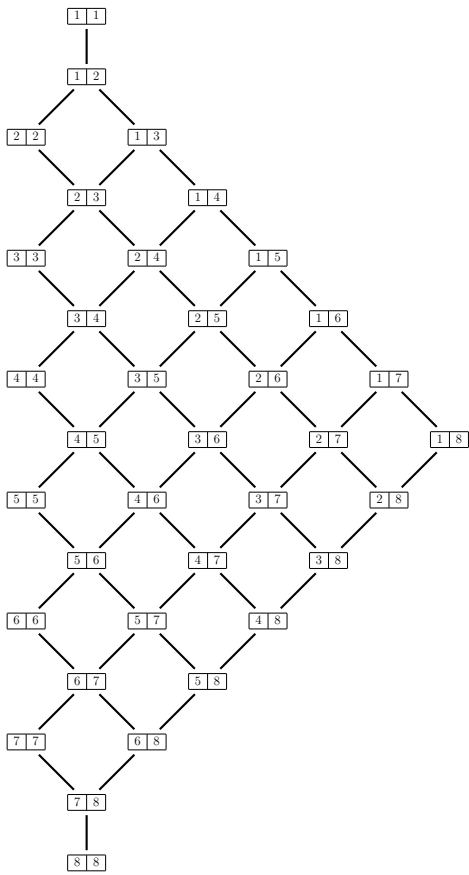
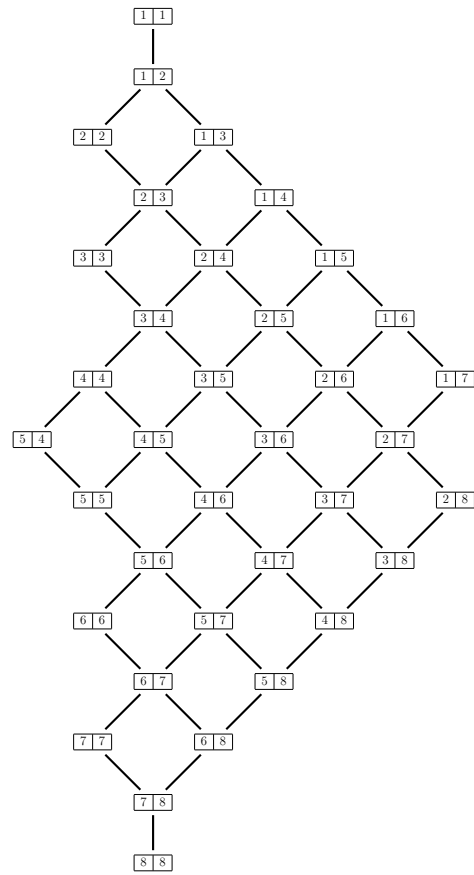
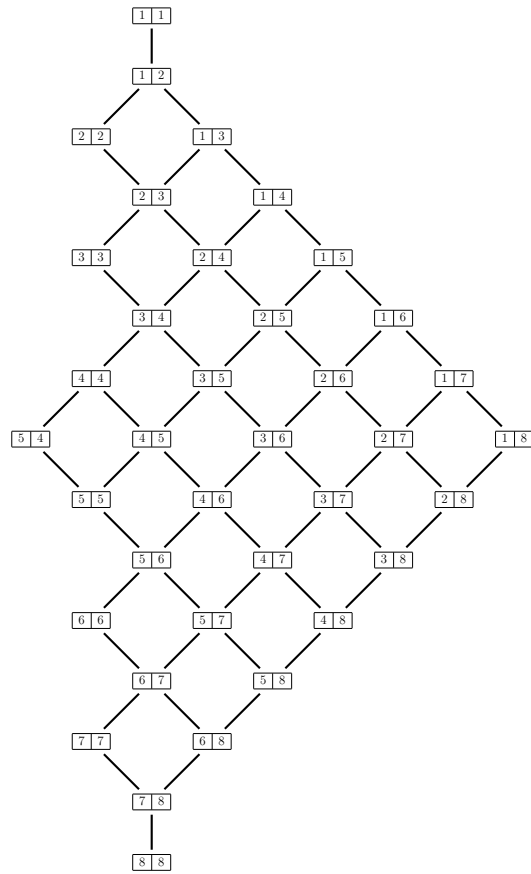

Figure 5.0.6: Molev, Reiner-Stanton, and Tilde graphs with $n = 3$ and $k = 2$.

(a) $L_C^{Mol}(4, 2\omega_1)$ (b) $L_C^{RS}(4, 2\omega_1)$

(c) $\widetilde{L}_C(4, 2\omega_1)$ Figure 5.0.7: Molev, Reiner-Stanton, and Tilde graphs with $n = 4$ and $k = 2$.

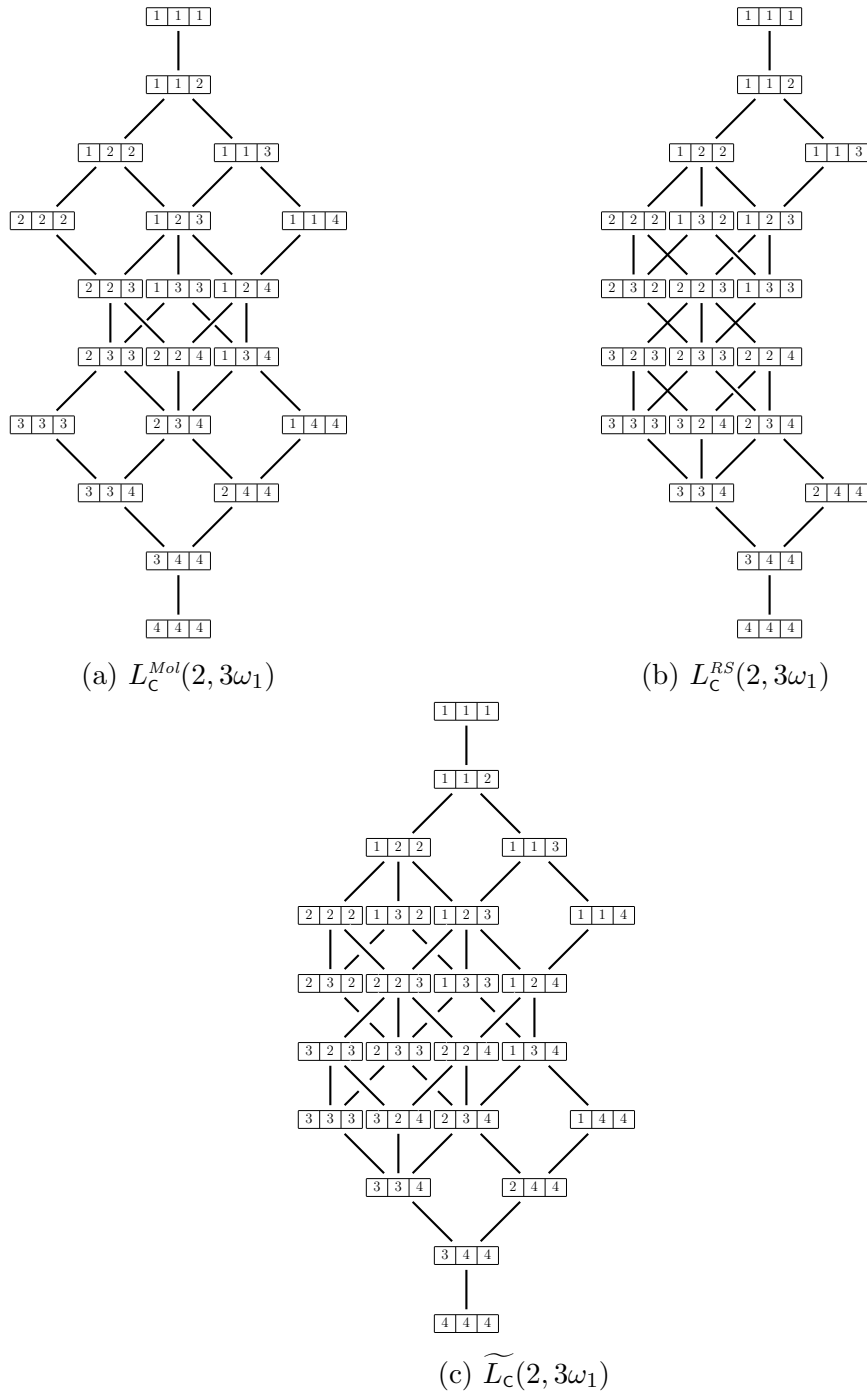

Figure 5.0.8: Molev, Reiner-Stanton, and Tilde graphs with $n = 2$ and $k = 3$.

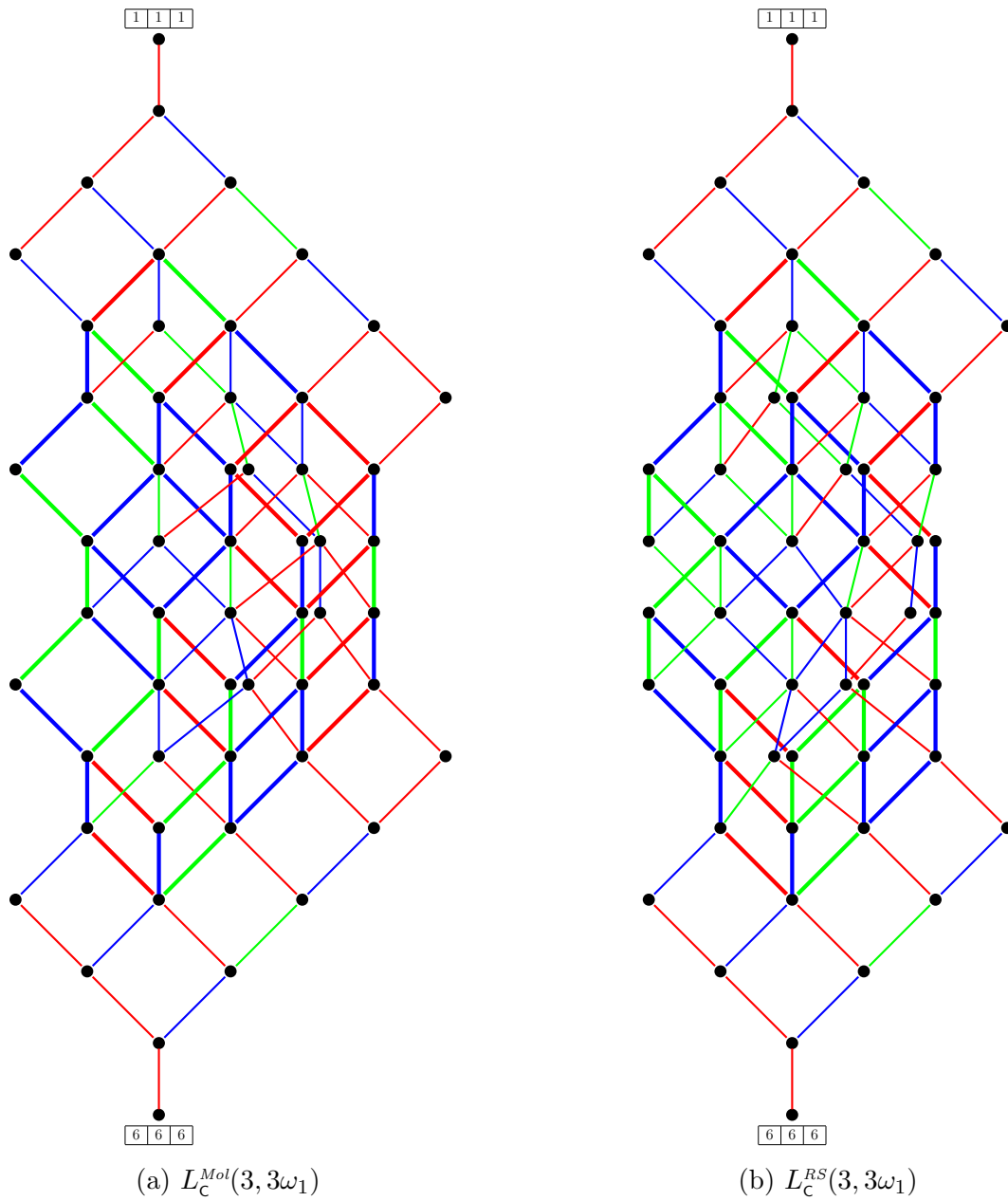

Figure 5.0.9: Type C lattices for Molev and Reiner-Stanton with $n = k = 3$.

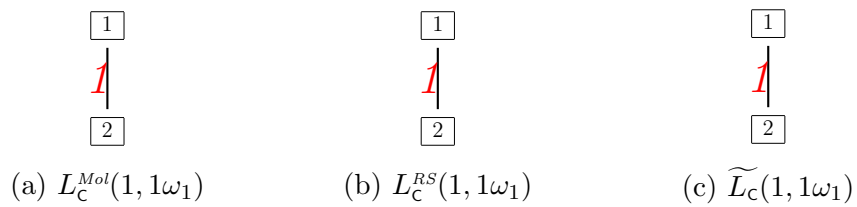
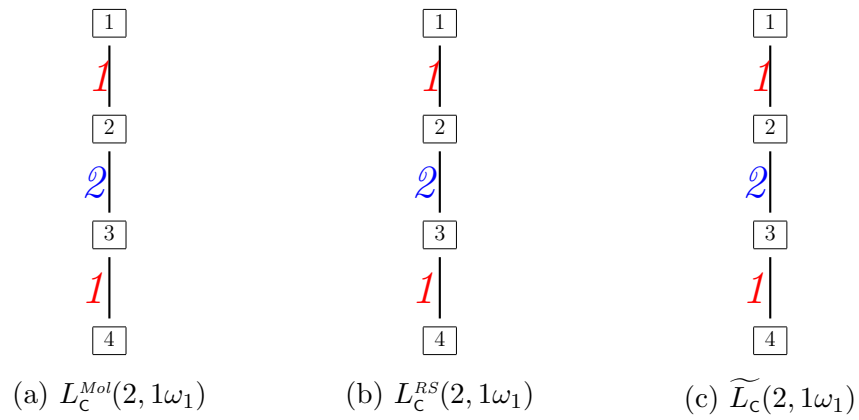
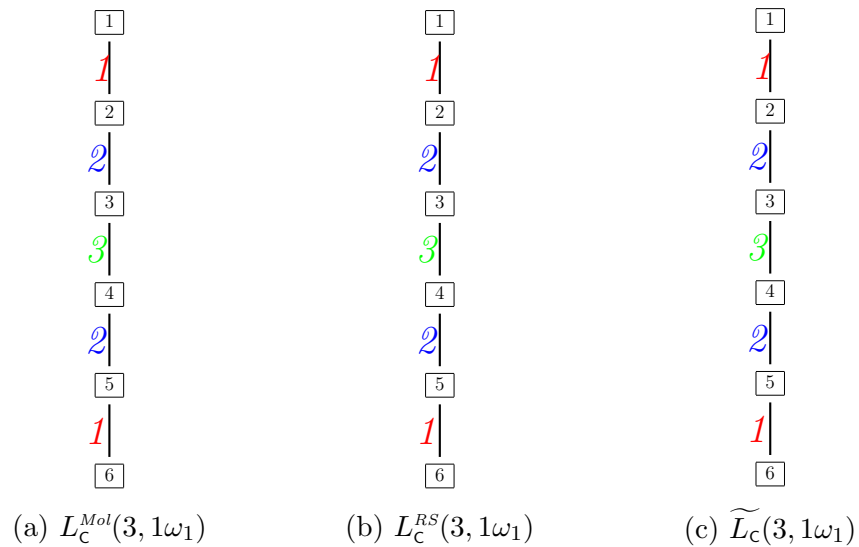

Figure 5.0.10: Molev, Reiner-Stanton, and Tilde graphs with $n = k = 1$.

Figure 5.0.11: Molev, Reiner-Stanton, and Tilde graphs with $n = 2$ and $k = 1$.Figure 5.0.12: Molev, Reiner-Stanton, and Tilde graphs with $n = 3$ and $k = 1$.

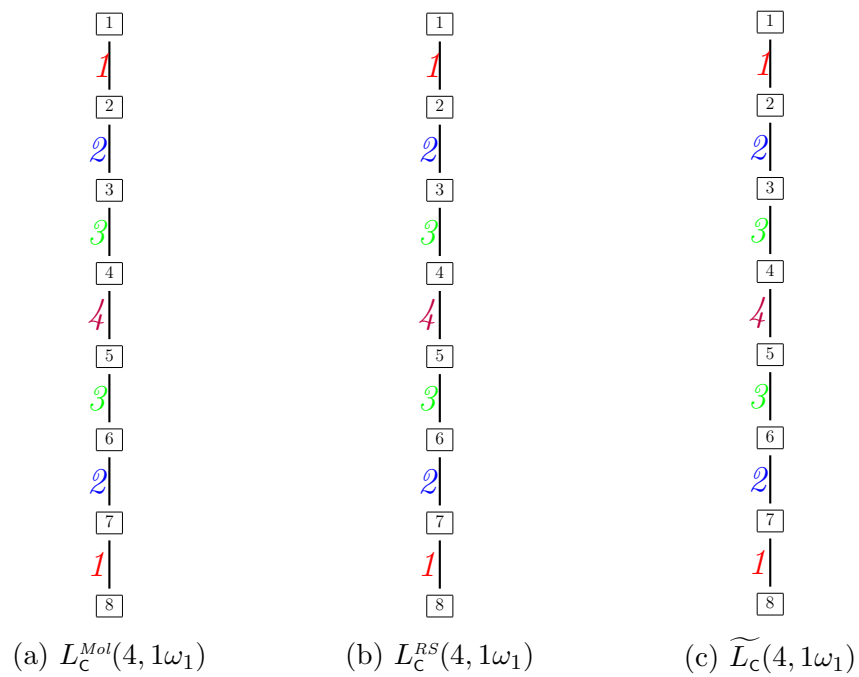

Figure 5.0.13: Molev, Reiner-Stanton, and Tilde graphs with $n = 4$ and $k = 1$.

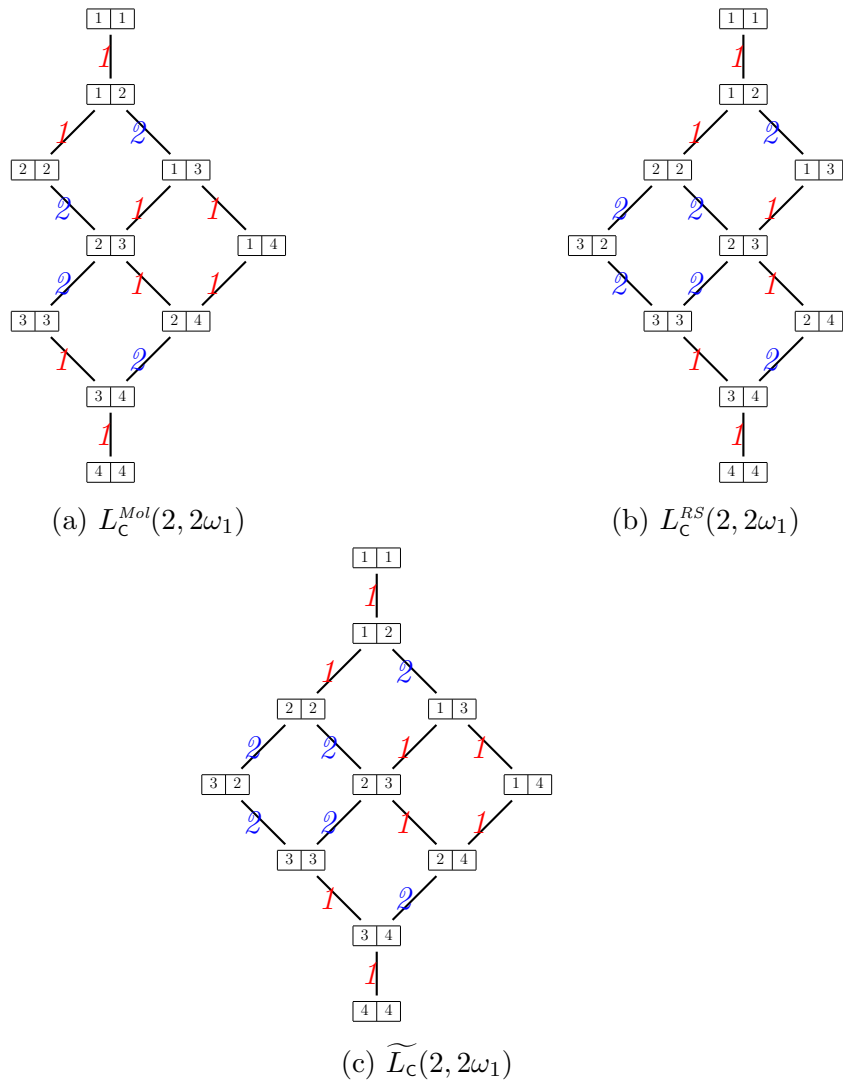

Figure 5.0.14: Molev, Reiner-Stanton, and Tilde graphs with $n = k = 2$.

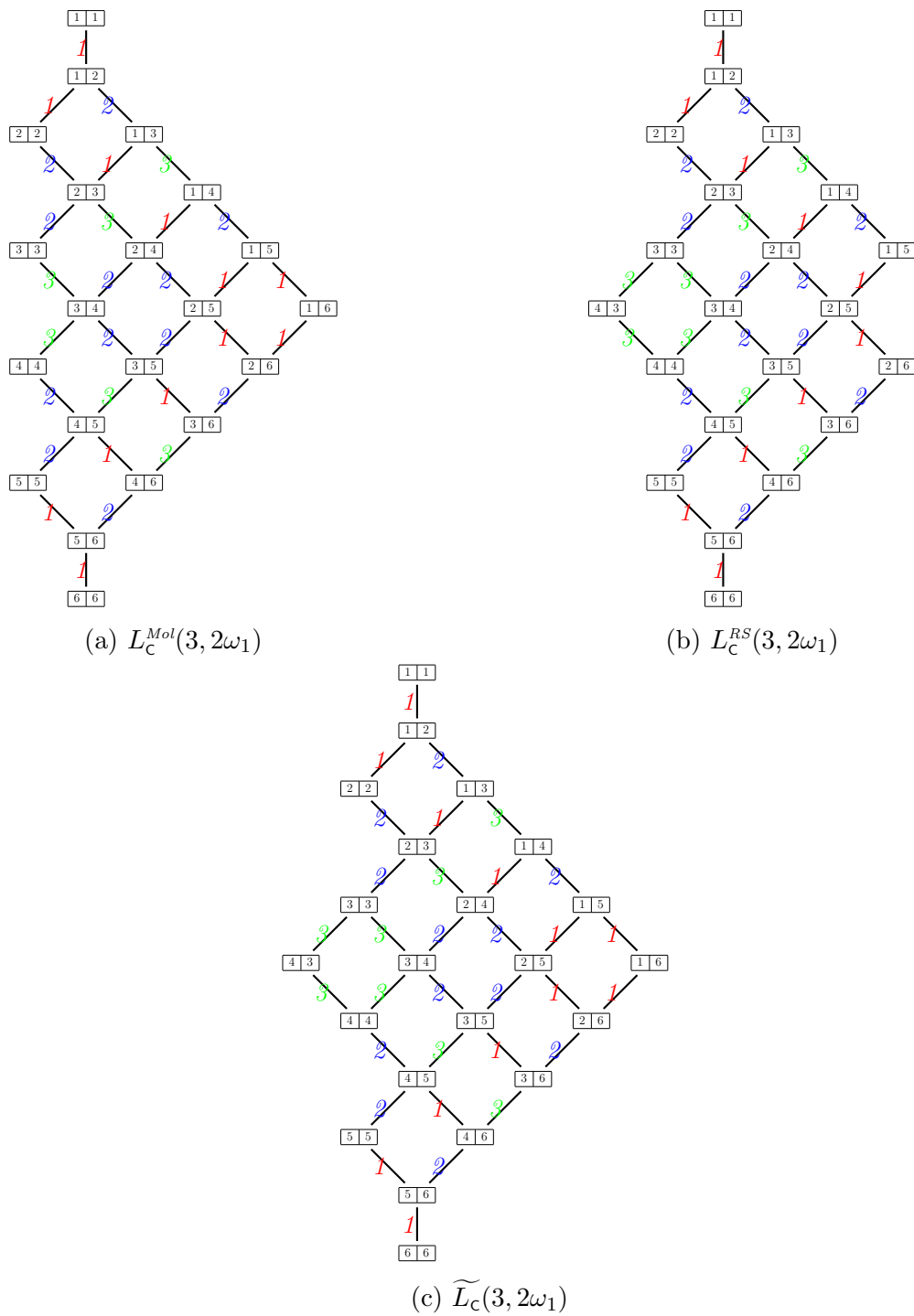

Figure 5.0.15: Molev, Reiner-Stanton, and Tilde graphs with $n = 3$ and $k = 2$.

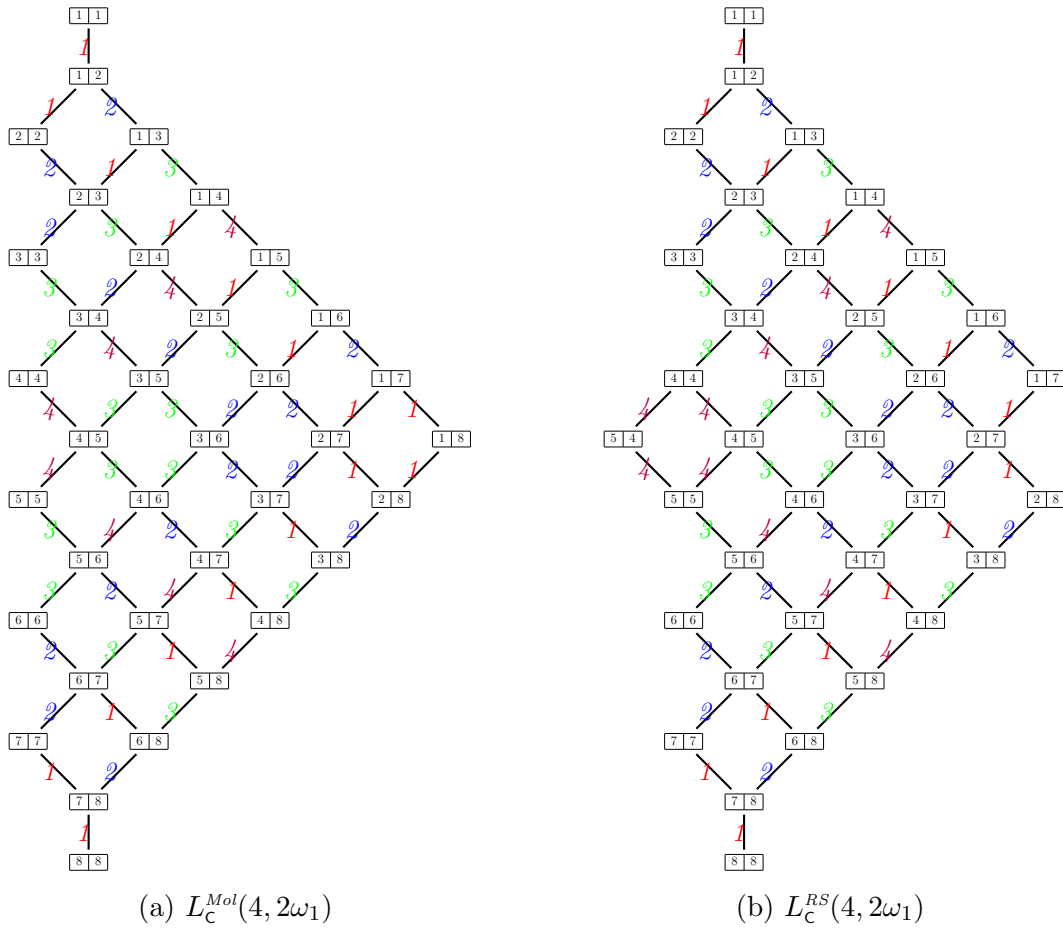
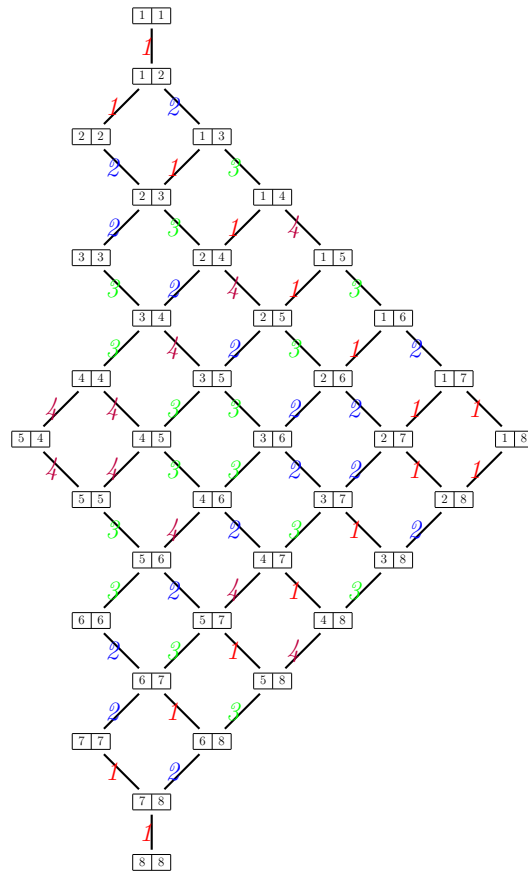

Figure 5.0.16: Molev and Reiner-Stanton graphs with $n = 4$ and $k = 2$.

(c) $\widetilde{L}_C(4, 2\omega_1)$ Figure 5.0.16: Tilde graph with $n = 4$ and $k = 2$.

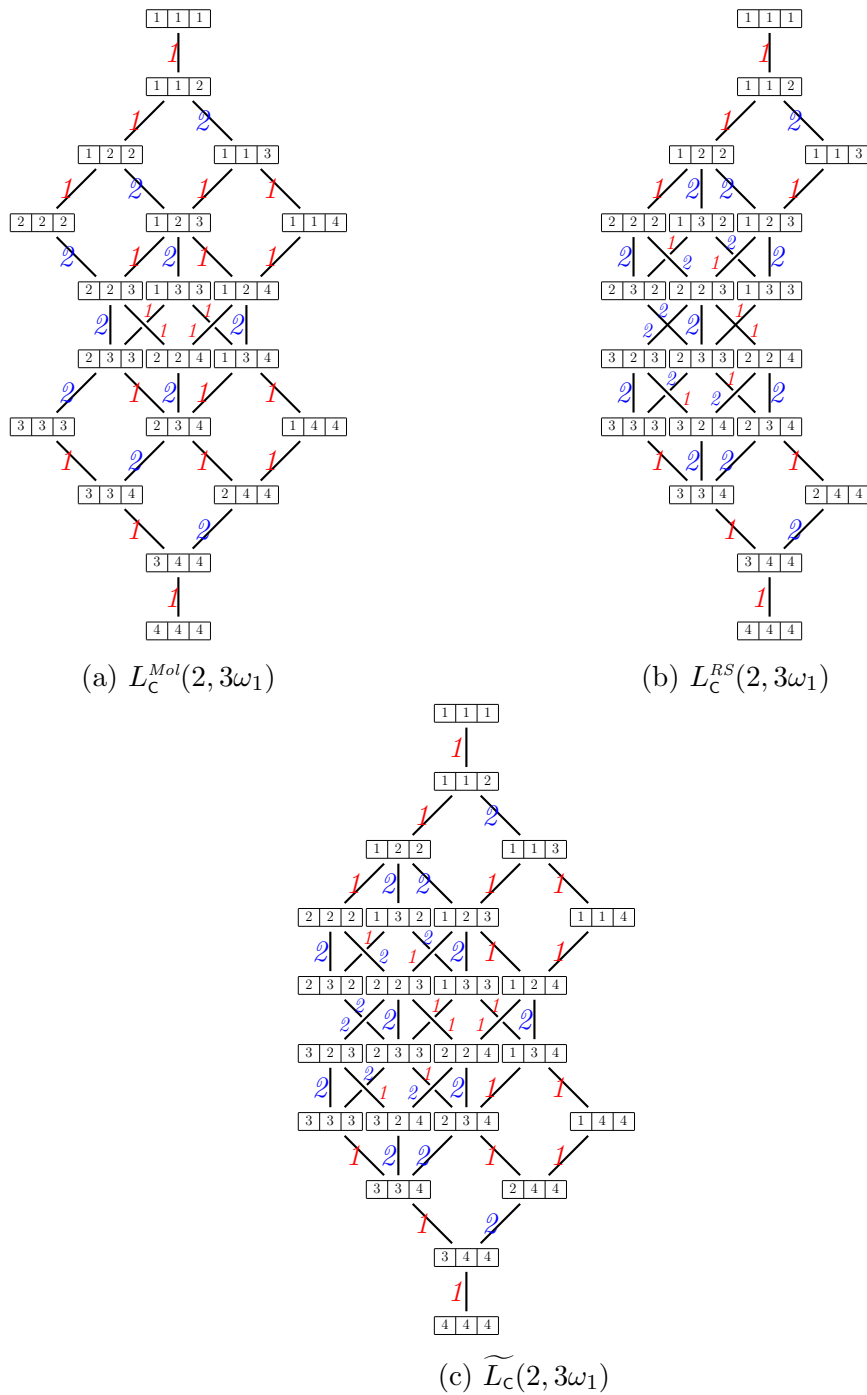

Figure 5.0.17: Molev, Reiner-Stanton, and Tilde graphs with $n = 2$ and $k = 3$.

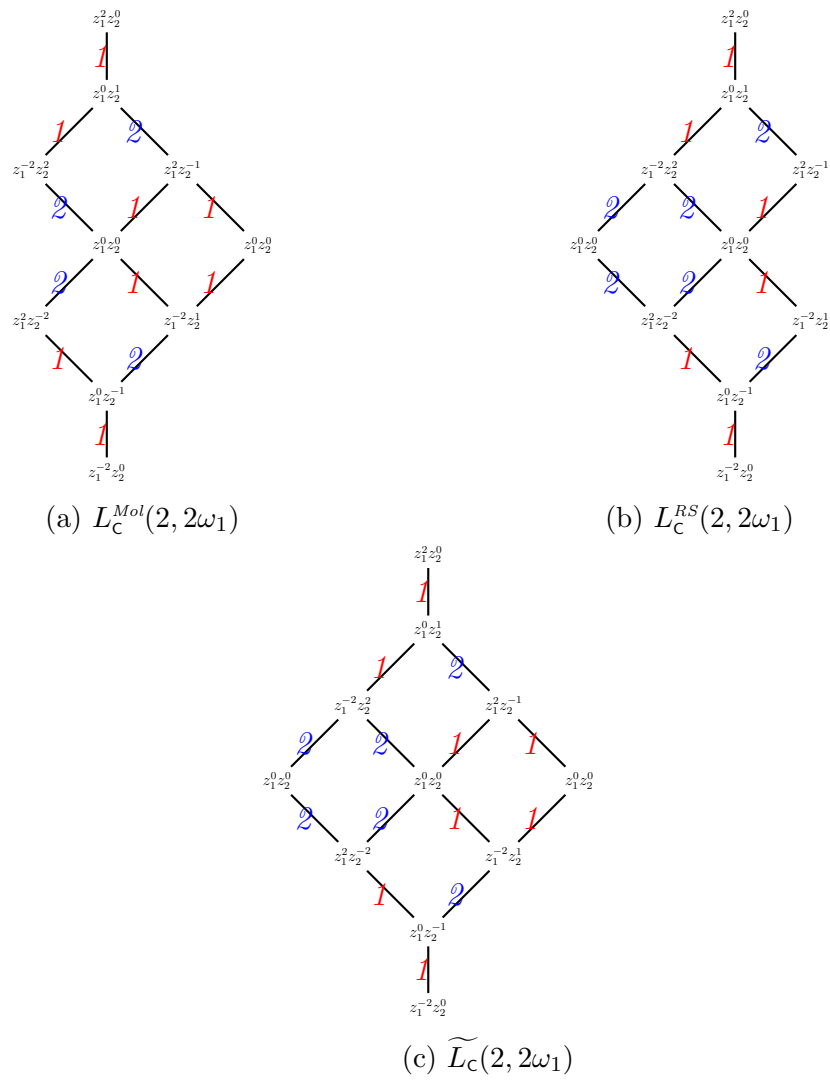
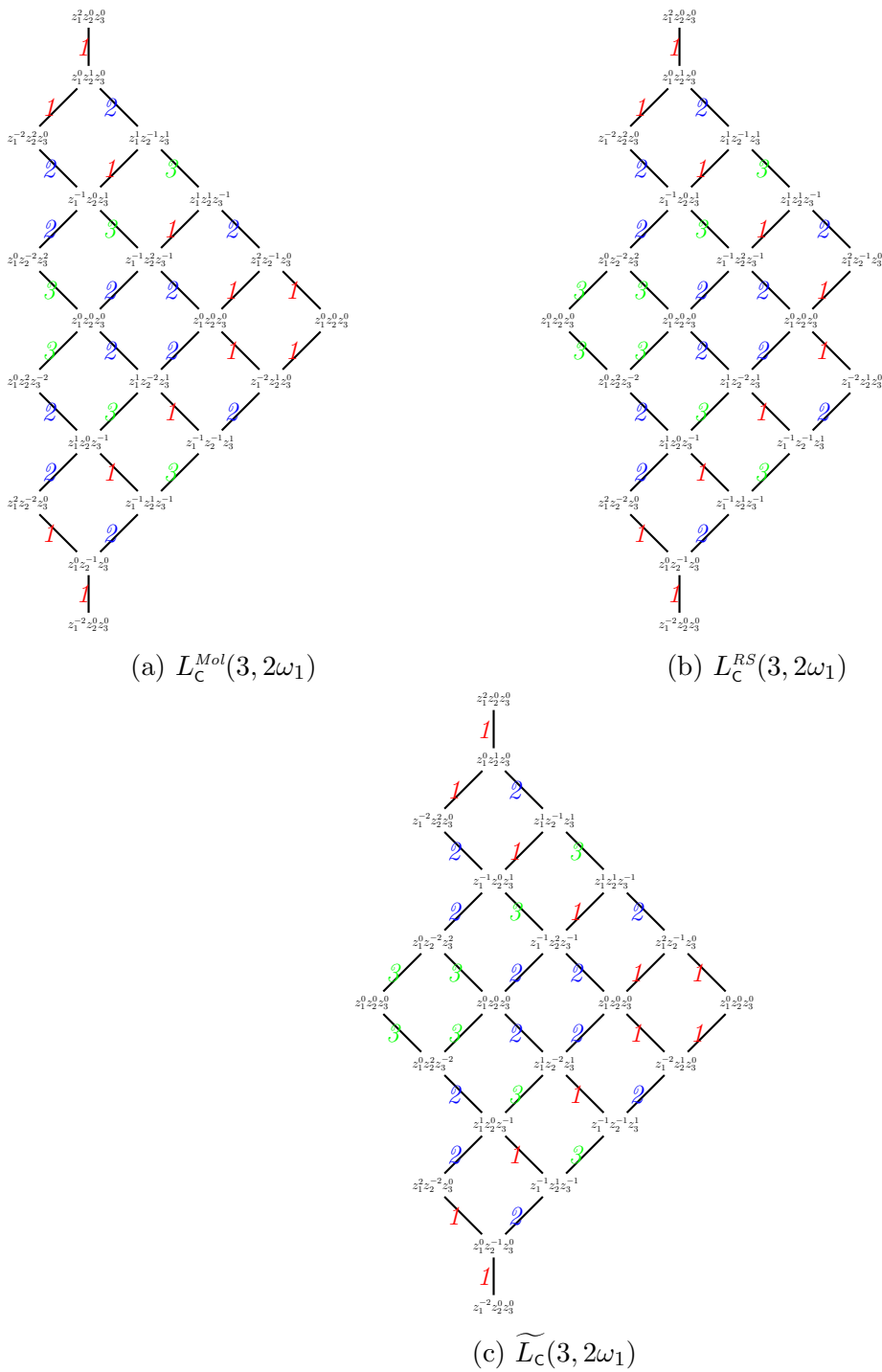
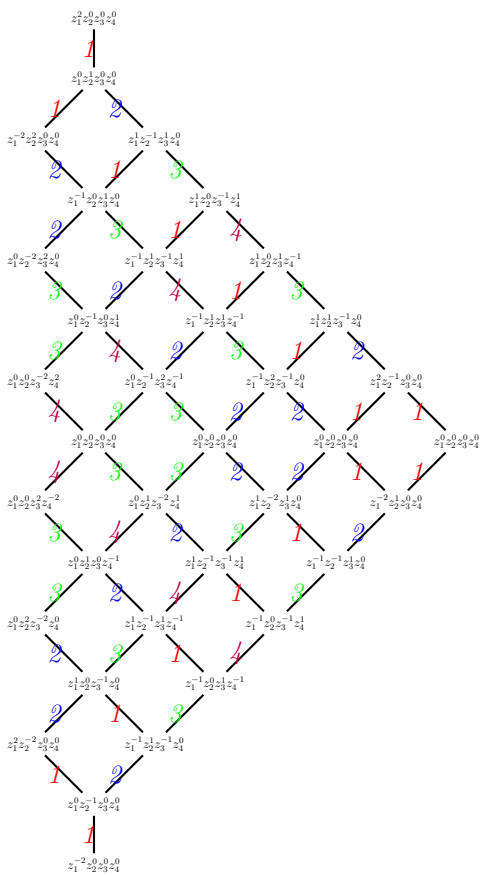
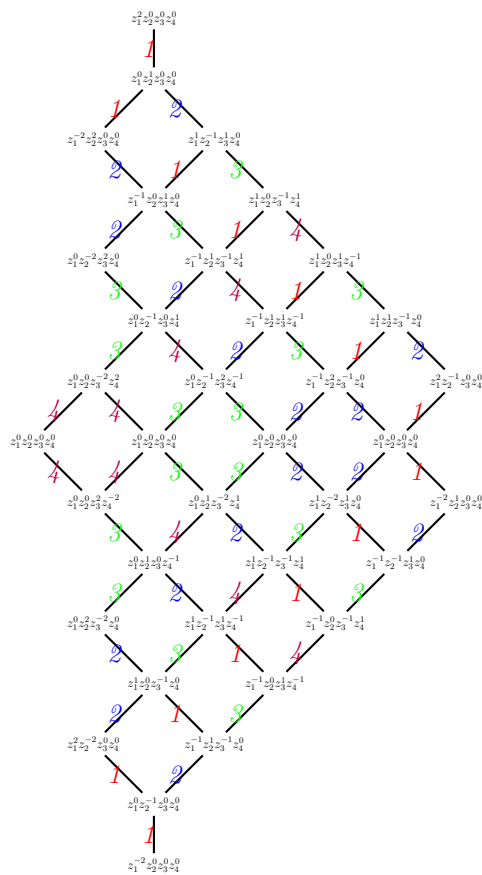
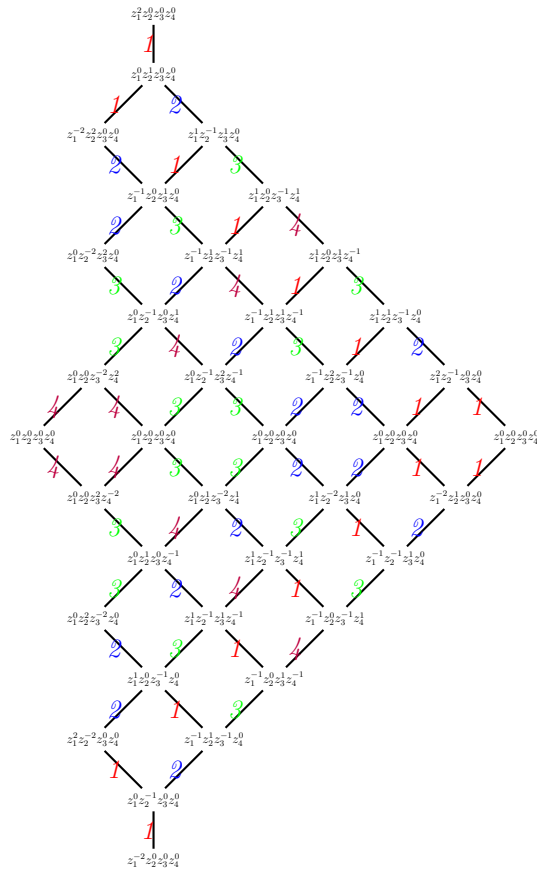

Figure 5.0.18: Molev, Reiner-Stanton, and Tilde graphs with $n = k = 2$.

Figure 5.0.19: Molev, Reiner-Stanton, and Tilde graphs with $n = 3$ and $k = 2$.

(a) $L_C^{Mol}(4, 2\omega_1)$ (b) $L_C^{RS}(4, 2\omega_1)$

(c) $\widetilde{L}_C(4, 2\omega_1)$ Figure 5.0.20: Molev, Reimer-Stanton, and Tilde graphs with $n = 4$ and $k = 2$.

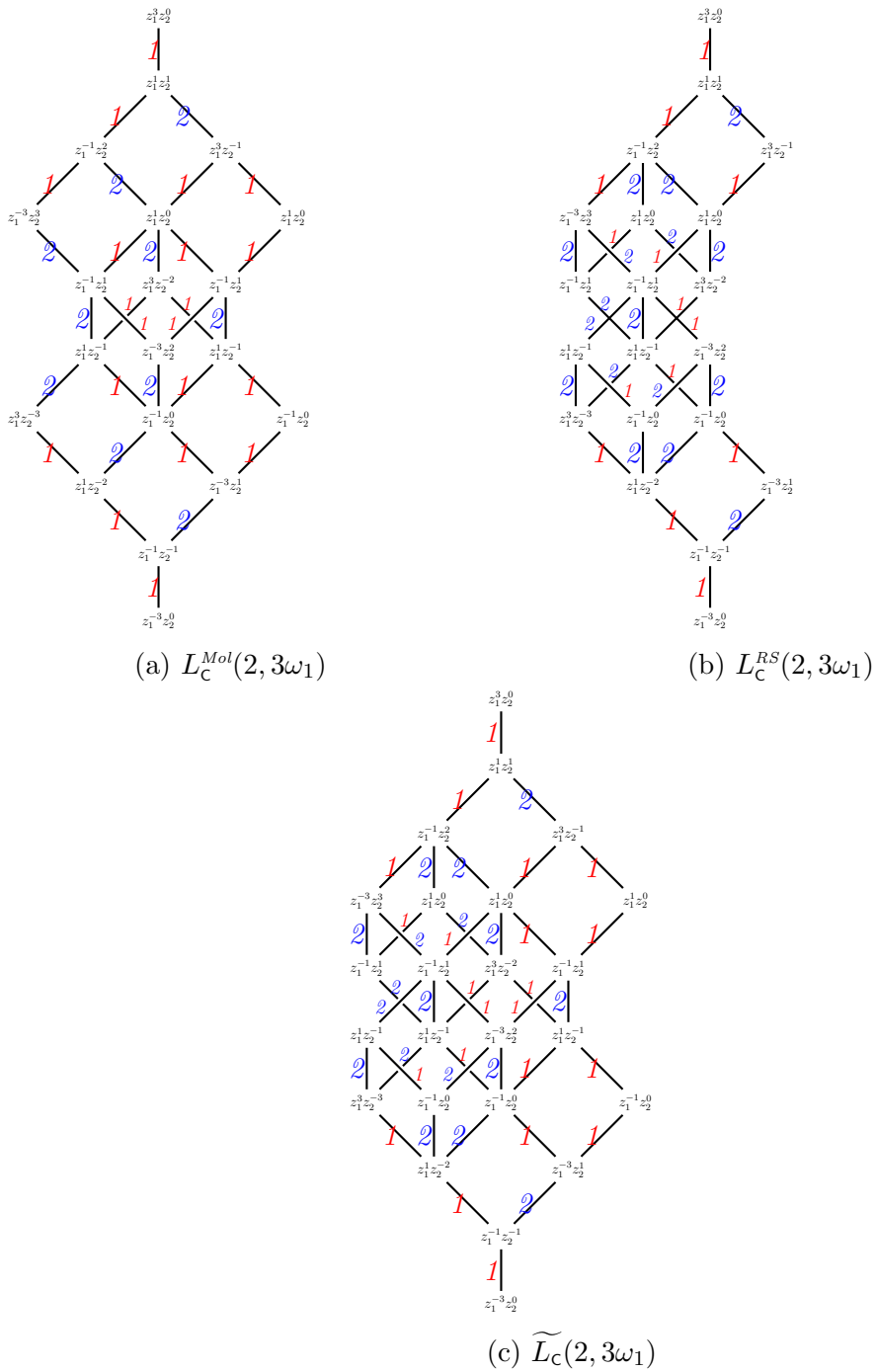

Figure 5.0.21: Molev, Reiner-Stanton, and Tilde graphs with $n = 2$ and $k = 3$.

References

- [Alv] L. W. Alverson II, “Distributive lattices and representations of the rank two simple Lie algebras,” Master’s thesis, Murray State University, 2003. Available at:
<http://campus.murraystate.edu/academic/faculty/rdonnelly/Research/WAThesis.pdf>
- [ADLP1] L. W. Alverson II, R. G. Donnelly, S. J. Lewis, and R. Pervine, “Constructions of representations of rank two semisimple Lie algebras with distributive lattices,” *Electronic J. Combin.* **13** (2006), #R109 (44 pp).
- [ADLP2] L. W. Alverson II, R. G. Donnelly, S. J. Lewis, and R. Pervine, “Analogues of Schur functions for rank two Weyl groups obtained from grid-like posets,” preprint, 2015.
- [Beck] K. A. Beck, “Distributive lattice models of the type B elementary Weyl group symmetric functions,” Master’s thesis, Murray State University, 2018.
- [Col] A. J. Coleman, “The greatest mathematical paper of all time,” *Math. Intelligencer* **11** (1989), 29–38.
- [Don1] R. G. Donnelly, “Extremal properties of bases for representations of semisimple Lie algebras,” *J. Algebraic Combin.* **17** (2003), 255–282.
- [Don2] R. G. Donnelly, “Eriksson’s numbers game and finite Coxeter groups,” *European J. Combin.* **29** (2008), 1764–1781.
- [Don3] R. G. Donnelly, “Poset models for Weyl group analogues of symmetric functions and Schur functions,” unpublished research manuscript, 2018.
- [DDDS] R. G. Donnelly, E. A. Donovan, M. W. Dunkum, and T. A. Schroeder, “Move-mini-mizing games and diamond-colored modular and distributive lattices (unabridged),” [arXiv](https://arxiv.org/abs/1808.08881).
- [DLP1] R. G. Donnelly, S. J. Lewis, and R. Pervine, “Constructions of representations of $\mathfrak{o}(2n + 1, \mathbb{C})$ that imply Molev and Reiner-Stanton lattices are strongly Sperner,” *Discrete Math.* **263** (2003), 61–79.
- [DLP2] R. G. Donnelly, S. J. Lewis, and R. Pervine, “Solitary and edge-minimal bases for representations of the simple Lie algebra G_2 ,” *Discrete Math.* **306** (2006), 1285–1300.

- [Gil] M. R. Gilliland, “Distributive Lattices and Weyl Characters of Exotic Type F_4 ,” Master’s thesis, Murray State University, 2008. Available at:
<http://campus.murraystate.edu/academic/faculty/rdonnelly/Research/MGThesis.pdf>
- [Hum] J. E. Humphreys, *Introduction to Lie Algebras and Representation Theory*, Graduate Texts in Mathematics vol. 8, Springer-Verlag, New York, 1972.
- [Kac] V. G. Kac, *Infinite-dimensional Lie Algebras*, 3rd edition, Cambridge University Press, Cambridge, 1990.
- [Knuth] D. E. Knuth, *The Art of Computer Programming, Vol. 1: Fundamental Algorithms*, Third Edition, Addison-Wesley, Reading MA, 1997.
- [Kum] S. Kumar, *Kac–Moody Groups, Their Flag Varieties and Representation Theory*, Birkhäuser Boston Inc, Boston, MA, 2002.
- [Mark] G. Markowsky, “Necessary and sufficient conditions for a phenotype system to have a factor union representation,” *Math. Biosciences*, **66** (1983), 115–128.
- [Mc] M. L. McClard, “Picturing Representations of Simple Lie Algebras of Rank Two,” Master’s thesis, Murray State University, 2000. Available at:
<http://campus.murraystate.edu/academic/faculty/rdonnelly/Research/MMThesis.pdf>
- [RS] V. Reiner and D. Stanton, “Unimodality of differences of specialized Schur functions,” *J. Algebraic Comb.* **7** (1998), 91–107.